

# INSTALLER MANUAL

Pellet Stove








©2024 CADEL srl | All rights reserved - Tutti i diritti riservati

**ZEFIRO - ZEN - PONENTE - ZENITH**

## SUMMARY

<b>1</b>	<b>MANUAL SIMBOLOGY</b> .....	<b>3</b>
<b>2</b>	<b>PACKAGING AND HANDLING</b> .....	<b>3</b>
2.1	PACKAGING .....	3
2.2	REMOVING THE STOVE FROM THE PALLET .....	3
2.3	STOVE HANDLING.....	4
<b>3</b>	<b>CHIMNEY FLUE</b> .....	<b>4</b>
3.1	PREPARING THE SMOKE EXPULSION SYSTEM.....	4
3.2	CHIMNEY COMPONENTS .....	4
3.3	SMOKE DUCT (SMOKE FITTING).....	5
3.4	FLUE (CHIMNEY OR PIPED DUCT) .....	5
3.5	CHIMNEY POT.....	6
3.6	MAINTENANCE .....	7
<b>4</b>	<b>COMBUSTION AIR</b> .....	<b>7</b>
4.1	AIR INLET .....	7
4.2	COMBUSTIBLE AIR INLET FOR SEALED-CHAMBER INSTALLATION .....	8
<b>5</b>	<b>EXAMPLES OF INSTALLATION (DIAMETERS AND LENGTHS TO BE SIZED)</b> .....	<b>9</b>
<b>6</b>	<b>INSTALLATION</b> .....	<b>10</b>
6.1	INTRODUCTION .....	10
6.2	MINIMUM DISTANCES.....	11
6.3	INSULATING MATERIAL.....	12
6.4	OVERALL DIMENSIONS .....	13
6.5	INSERT EXTRACTION .....	17
6.6	INSERT REMOVAL.....	17
6.7	INSTALLATION WITH EXTERNAL COVER.....	18
6.8	INSTALLATION ON EXISTING FIREPLACE.....	20
6.9	DOOR ADJUSTMENT (ZEN - ZEFIRO) .....	22
6.10	DOOR ADJUSTMENT (PONENTE - ZENITH).....	22
6.11	CONNECTION TO THE EXTERNAL THERMOSTAT .....	22
6.12	ELECTRIC CONNECTION .....	23
6.13	AIR REGULATOR .....	23
6.14	INSERT LEGS INSTALLATION (OPTIONAL) .....	24
6.15	HOT AIR DUCTING (OPTIONAL ONLY FOR ZEFIRO) .....	25
6.16	PELLET DRAWER INSTALLATION (OPTIONAL).....	27
6.17	TRAPDOOR INSTALLATION (OPTIONAL).....	29
6.18	FRAME INSTALLATION (OPTIONAL) .....	31
6.19	CONCENTRIC PIPE INSTALLATION .....	32
6.20	DISPLAY ROTATION .....	32
<b>7</b>	<b>WI-FI KIT INSTALLATION</b> .....	<b>33</b>
<b>8</b>	<b>SPECIAL MAINTENANCE</b> .....	<b>34</b>
8.1	INTRODUCTION .....	34
8.2	FEED SCREW MAINTENANCE.....	34
8.3	ROOM FAN CLEANING .....	35
8.4	FLUE GAS EXTRACTOR CLEANING.....	36
8.5	FUME PASSAGES CLEANING.....	36
8.6	FUME CHAMBER CLEANING .....	37
8.7	SMOKE DUCT CLEANING .....	38
8.8	GLASS REPLACEMENT .....	39
<b>9</b>	<b>IN CASE OF ANOMALY</b> .....	<b>39</b>
9.1	PROBLEM SOLVING .....	39
<b>10</b>	<b>TECHNICAL DATAS</b> .....	<b>41</b>
10.1	FUSE REPLACEMENT .....	41
<b>11</b>	<b>FEATURES</b> .....	<b>42</b>

## 1 MANUAL SIMBOLOGY

	<b>USER</b>
	<b>AUTHORISED TECHNICIAN</b> <b>(ONLY to interpret or the Stove-manufacturer or the Authorized Technician of Technical Assistance Service approved by the Stove-manufacturer)</b>
	<b>SPECIALIZED STOVE-REPAIRER</b>
	<b>CAUTION:</b> <b>READ CAREFULLY THE NOTE</b>
	<b>CAUTION:</b> <b>DANGER OR IRREVERSIBLE DAMAGE POSSIBILITY</b>

- The icons with the stylized figures indicates whom the subject dealt in the paragraph is addressed to (between the User and/or the Authorized Technician and/or the Specialized Stove-repairer).
- WARNING symbols indicates an important note.

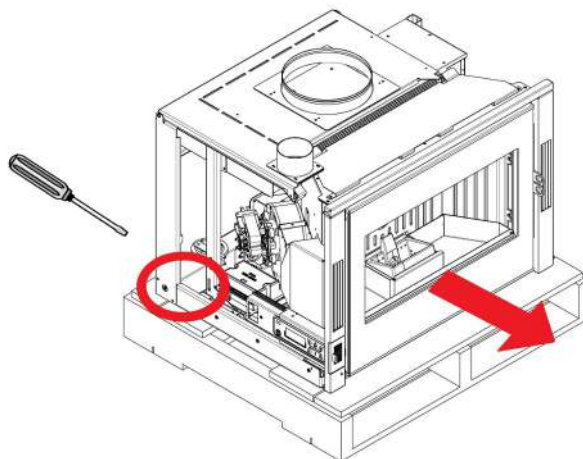
## 2 PACKAGING AND HANDLING

### 2.1 PACKAGING

- The packaging is made up of recyclable cardboard boxes according to RESY standards, recyclable expanded polystyrene inserts and wooden pallets.
- All packaging materials can be re-used for a similar use or eventually discharged as waste assimilable to the municipal solid ones, in accordance with current regulations.
- After having removed the packaging please assure you about the integrity of the product.

### 2.2 REMOVING THE STOVE FROM THE PALLET

Proceed as follows to remove the stove from the pallet:



*Fig. 1 - Screw removal*

- Slightly pull out the machine body from the structure (see **INSERT EXTRACTION** a pag. 17)
- Remove the screws fixed to the base of the insert (see **Fig. 1**) and then remove it from the pallet.

### 2.3 STOVE HANDLING

Both whether the stove is packed or not it is necessary to observe the following instructions for handling and transporting the stove from its sale point to its installation point and for any future movements:

- The stove must be handled with idoneous means paying attention to the existing safety regulations;
- do not turn the stove upside down and/or upset it on one side, but keep it in vertical position or as accorded with the constructor instructions;
- if the stove is made up of ceramic, stone, glass or any particularly fragile material components, all must be moved with the utmost care.

## 3 CHIMNEY FLUE

### 3.1 PREPARING THE SMOKE EXPULSION SYSTEM

The combustion product expulsion system is a particularly important element for the proper operation of the appliance and must be correctly sized according to EN 13384-1.

Its creation/adaptation/verification must always be carried out by a legally qualified operator and must comply with the regulations in force in the country where the appliance is installed.

The Manufacturer declines all liability for malfunctions caused by a badly sized and non-compliant smoke expulsion system.

### 3.2 CHIMNEY COMPONENTS

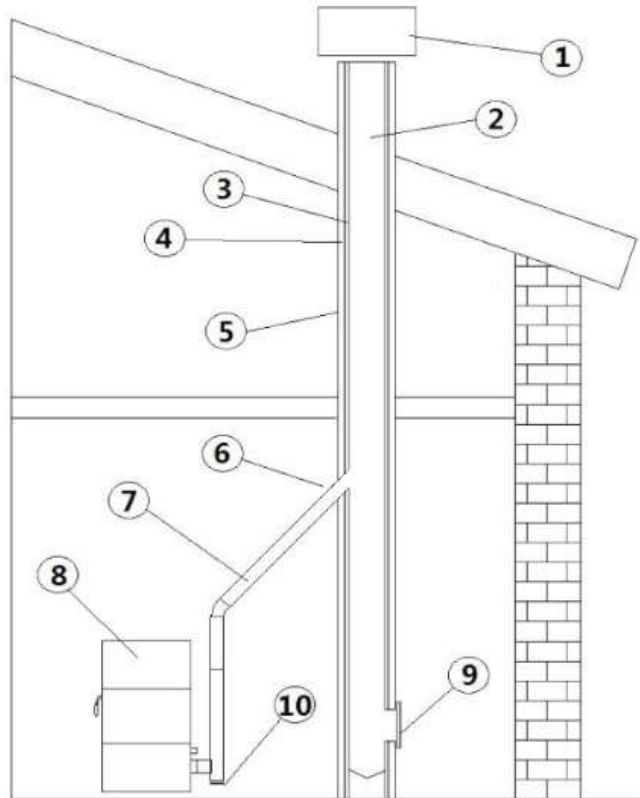


Fig. 2 - Chimney components

LEGEND	Fig. 2
1	Chimney pot
2	Fume outlet
3	Chimney flue
4	Termal insulation
5	External wall
6	Chimney union
7	Fume pipe
8	Heat generator
9	Inspection door
10	T-union with inspection plug

### 3.3 SMOKE DUCT (SMOKE FITTING)

The smoke duct is the pipe that connects the appliance to the flue.

This smoke fitting must comply in particular with the following requirements:

- comply with product standard EN 1856-2;
- its cross-section must be of constant diameter and no less than that of the appliance outlet, from the firebox outlet up to the connection in the flue;
- the horizontal section must be as short as possible and extend no more than 4 metres;
- the horizontal sections must have a minimum upward slope of 3%;
- changes of direction must have an angle no greater than 90° and be easy to inspect
- the number of changes of direction, including that for entry into the flue, and exclusion of the T in the event of a side or rear outlet, must not exceed 3;
- it must be insulated if it passes outside the installation room
- it must not in any case cross rooms in which it is forbidden to install combustion appliances.
- the use of flexible metal and fibre cement or aluminium hoses is forbidden;

In any case, smoke ducts must be sealed against combustion products and any condensation. For this reason, it is recommended to use pipes with silicone gaskets or similar sealing devices that withstand the operating temperatures of the appliance (e.g. T200 P1) and that by removing the gaskets, are still T400 N1 G certified.

SYSTEM TYPE	Ø80 mm PIPE	Ø100 mm PIPE
Minimum vertical length	1,5 mt	2 mt
Maximum length (with 1 union)	6,5 mt	10 mt
Maximum length (with 3 unions)	4,5 mt	8 mt
Maximum number of unions	3	3
Level section (minimum inclination 3%)	4 mt	4 mt
Installation at a height above 1200 m a.s.l.	NO	Obligatory

### 3.4 FLUE (CHIMNEY OR PIPED DUCT)

When creating the flue, in particular comply with the following requirements:

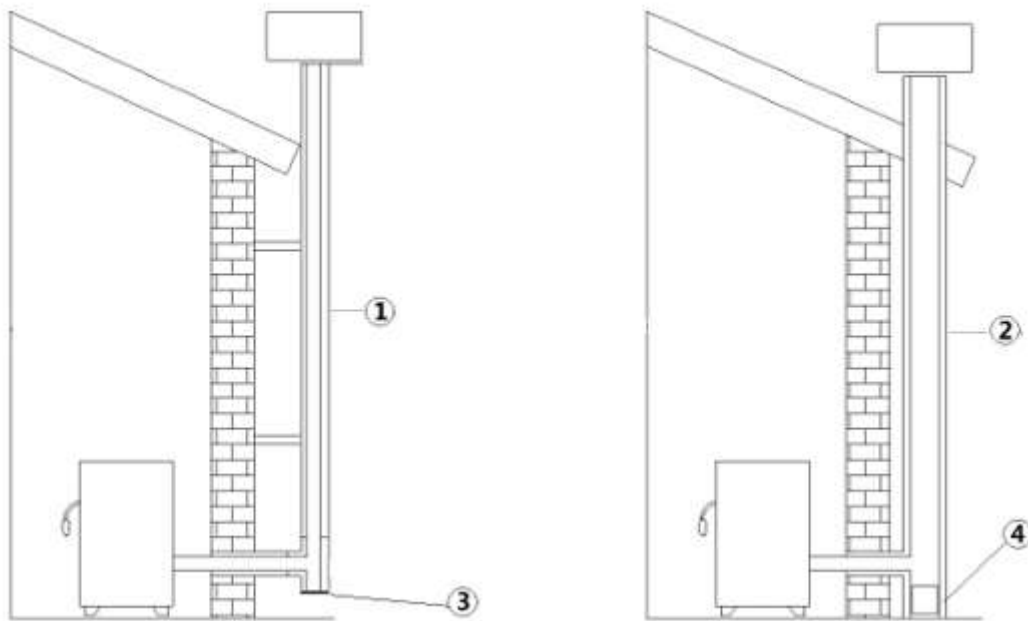
- comply with the applicable product standard (EN 1856, EN 1857 EN 1457, EN 1806, EN 13063..);
- be made with suitable materials to ensure resistance to normal mechanical, chemical, thermal stresses and have adequate thermal insulation in order to limit the formation of condensate;
- have a predominantly vertical configuration and be free of choke points along its entire length;
- be correctly spaced by air gaps and isolated from combustible materials;
- the flue inside the house must still be insulated and can be inserted in an air shaft provided it complies with the regulations for piping;
- the smoke duct must be connected to the flue by means of a Tee fitting with an inspectable collection chamber for the collection of soot and any condensate.
- where the sizing provides for wet operation, a suitable condensate collection and siphon discharge system must be set up.



***We recommend checking the data plates of the flue for the safety distances that must be observed in the presence of combustible materials and, if necessary, the type of insulating material to be used.***

***It is forbidden to connect the stove to a collective or shared flue with other combustion appliances or with hood outlets.***

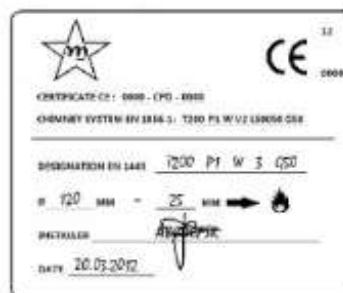
***It is forbidden to use the direct drain on the wall or towards indoor spaces and any other form of drain not provided for by the regulation in force in the country of installation.***



**Fig. 3 - Chimney Flues**

LEGEND	Fig. 3
1	Chimney flue with insulated stainless-steel pipes
2	Chimney flue on the existing chimney
3	Inspection plug
4	Inspection door

- The chimney flue must be provided CE in accordance with EN 1443 regulation. Please find attached an example of label:



**Fig. 4 - Example of label**

### 3.5 CHIMNEY POT

The chimney pot, meaning the end part of the flue, must meet the following characteristics:

- the smoke outlet section must be at least double the internal section of the chimney;
- prevent the penetration of rain or snow;
- ensure the outlet of smoke even in the event of wind (windproof chimney pot);
- the height of outflow must be beyond the reflux area (\*\*) (refer to national regulations to identify the reflux area);
- always be built at a distance from antennas or dishes, and never be used as a support.

(\*\*) unless there are specific national derogations (clearly specified in the corresponding instruction manual in English) which under appropriate conditions allow it; in this case, strictly follow the product/installation requirements of the relative regulations/technical specifications/legislation in force in that country.

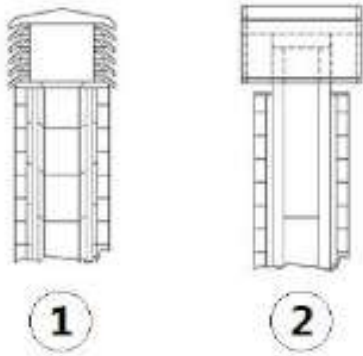


Fig. 5 - Anti-wind chimney pots

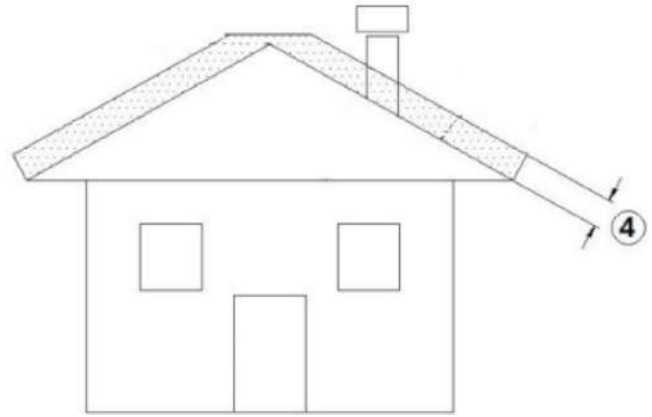


Fig. 6 - Reflux area

### 3.6 MAINTENANCE

- The fumes extraction pipes (fumes conduit + chimney flue + chimney pot) must always be cleaned, scrubbed and checked by an expert stove-repairer, in compliance with current regulations, with the instructions of the stove-manufacturer and the directives of your insurance company.
- In case of doubts, please follow the most restrictive regulations.
- Have your chimney flue and chimney pot checked and cleaned by an expert chimney sweep at least once a week. The chimney sweep has to release a written declaration about the security of the system.
- Not cleaning compromise safety.

## 4 COMBUSTION AIR

### 4.1 AIR INLET

It is mandatory to provide an adequate external air inlet that supplies the combustion air required for the product to work properly. The flow of air between the outside and the installation room can take place with a free air inlet or by channelling the air directly to the outside (\*\*\*)

The free air inlet must be:

- be made at floor level and in any case not higher than the height of the appliance;
- always be protected with an outer grille and in such a way that it cannot be obstructed by any object;
- have a minimum total free area of 80 cm<sup>2</sup> (net of the grille);

The presence of other suction devices (e.g.: vmc, electric fan for stale air extraction, kitchen hood, other stoves, etc.), in the same room, or in communicating rooms of the same housing unit, could cause negative pressure in the room. In this case, with the exception of sealed installations, one must verify that, with all the equipment on, no more than 4 Pa of negative pressure is created inside the installation room with respect to the outside. If necessary, increase the air inlet section.

It is possible to duct the air required for combustion to the outside by connecting the external air inlet directly with the combustion air inlet which is usually found on the back of the appliance.

The external ducted air vents must be:

- made close to the floor and anyway not higher than the appliance
- protected by a grille that guarantees a clear surface equal to the cross-section of the duct and made so that it cannot be obstructed by any object
- The air vent can be made directly on a wall of the installation room communicating with the outside, or indirectly in adjacent rooms that permanently communicate with the installation room, according to that set forth by standards in force.

The duct must comply with the following dimensions (each 90° bend is equivalent to one linear metre):

(\*\*\*) In the event the combustion air is ducted on unsealed products, still verify that no more than 4 Pa of negative pressure is created inside the installation room with respect to the outside, otherwise provide for an additional air intake in the room.

### Below 15 kW:

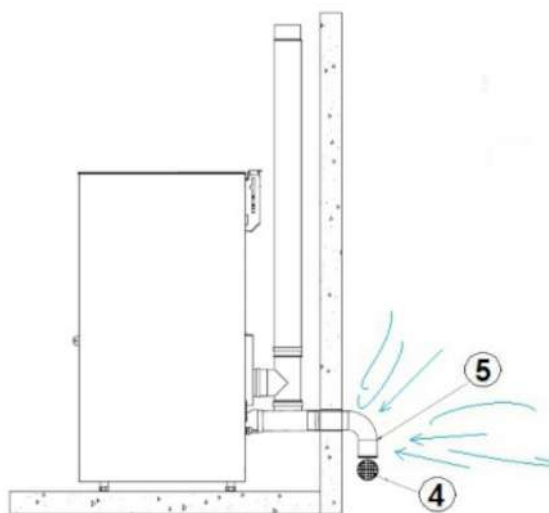
Air duct diameter	Maximum length (smooth duct)	Maximum length (corrugated duct)
50 mm	2 m	1 m
60 mm	3 m	2 m
80 mm	7 m	4 m
100 mm	12 m	9 m

### Above 15 kW:

Air duct diameter	Maximum length (smooth duct)	Maximum length (corrugated duct)
50 mm	-	-
60 mm	1 m	-
80 mm	3 m	1 m
100 mm	7 m	4 m



**Fig. 7 - Direct air inflow**

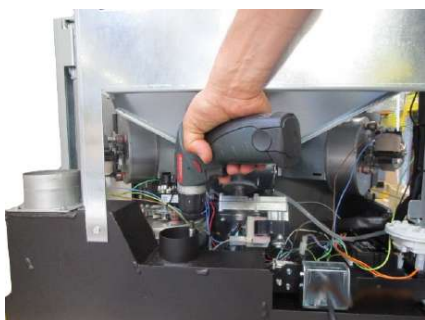


**Fig. 8 - Air inlet for sealed-chamber installation**

LEGEND	Fig. 7 Fig. 8
1	Room to ventilate
2	External air inlet
4	Shield grid
5	Curve inlet to turn downwards

## 4.2 COMBUSTIBLE AIR INLET FOR SEALED-CHAMBER INSTALLATION

How to connect to the stove in the sealed chamber with concentric system:



**Fig. 9 - Phase 1**



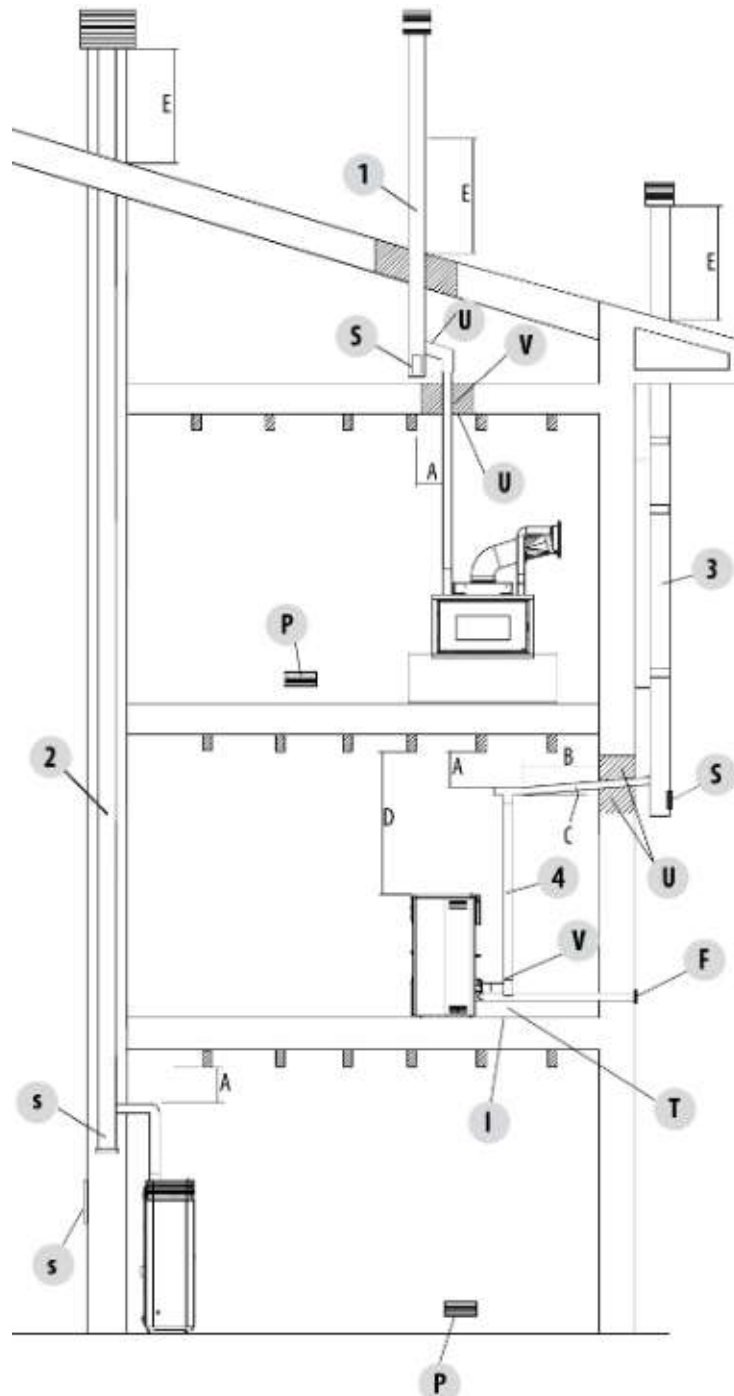
**Fig. 10 - Phase 2**



**Fig. 11 - Phase 3**

- Remove the ring inside the combustion air fitting (see **Fig. 9** and **Fig. 10**).
- Insert the concentric pipe as in **Fig. 11**.

## 5 EXAMPLES OF INSTALLATION (DIAMETERS AND LENGTHS TO BE SIZED)



**Fig. 12 - Chimney flue**

1. Flue installation with hole for the passage of the pipe increased by:
  - minimum 100mm around the pipe if next to non-flammable parts such as cement, brick, etc.;
  - or minimum 300mm around the pipe (or as required by plate data) if next to flammable parts such as wood etc.
 In both cases, install suitable insulation between the flue and the ceiling.  
 Always check and comply with the plate data of the flue, specifically the minimum safety distances from combustible materials.  
 The previous rules also apply for holes made in walls.
2. Old flue, pipe with the inclusion of an external access door for chimney cleaning.
3. External flue made of insulated stainless-steel pipes, i.e. with double walls: all securely mounted on the wall. With windproof chimneypot.
4. Ducting system using Tee fittings that allow easy access for cleaning without having to remove the pipes.

LEGEND	Fig. 12
<b>U</b>	Insulation
<b>V</b>	Possible diameter increase
<b>I</b>	Inspection cap
<b>S</b>	Inspection access panel
<b>P</b>	Air inlet
<b>T</b>	T-fitting with inspection cap
<b>A</b>	Distance from flammable material (smoke duct plate)
<b>B</b>	Maximum 4 m
<b>C</b>	Minimum 3° slope
<b>D</b>	Distance from flammable material (appliance plate)
<b>E</b>	Reflux area
<b>F</b>	Air ducting



The instructions in this chapter refer explicitly to the Italian installation regulation UNI 10683. In any case, always observe the regulations in force in the country of installation.

## 6 INSTALLATION

### 6.1 INTRODUCTION

**The heating system (generator + combustion air supply + combustion product expulsion system + any hydraulic/aeraulic system) must be installed in compliance with the laws and regulations in force (\*), and carried out by a qualified technician, who must issue a declaration of conformity of the system to the system manager and shall undertake full responsibility for final installation and consequent good operation of the product.**

The manufacturer declines all responsibility in the event of installations that do not comply with the laws and regulations in force and inappropriate use of the appliance.

In particular one must ensure that:

- the environment is suitable for installing the appliance (floor load-bearing capacity, presence or possibility of creating an adequate electrical/hydraulic/aeraulic system when required, volume compatible with the appliance characteristics, etc.);
- the appliance is connected to a smoke expulsion system correctly sized according to EN 13384-1, which is resistant to soot fire and which complies with the distances prescribed by the combustible materials indicated on the plate data;
- there is a suitable combustion air flow to the appliance;
- other combustion appliances or extraction devices installed do not cause a negative pressure of more than 4 Pa in the room where the product is installed compared to the outside (only sealed appliances are allowed a maximum of 15 Pa of negative pressure in the room).

(\*): *The national reference standard for the installation of domestic appliances is UNI 10683 (IT) - DTU NF 24.1 (FR) - DIN 18896 (DE) - NBN B 61-002 (BE) - Real Decreto 1027/2007 (ES) - Paesi Bassi (NL) Bouwbesluit - Danmark (DK) BEK n° 541 del 27/04/2020.*

**In particular, it is recommended to strictly observe the safety distances from combustible materials to avoid serious harm to people and to the integrity of the home.**

Installation of the appliance must ensure easy access to service the appliance itself, the smoke channels and the flue. Always maintain adequate distance and protection in order to prevent the product from coming into contact with water.

**It is forbidden to install the stove in rooms with a fire hazard.**

**With the exception of sealed installations, it is also forbidden for liquid fuel appliances with continuous or intermittent operation that draw the combustion air from the room they are installed in or B-type gas heating appliances, with or without the production of domestic hot water, to coexist in the same room or in interconnecting rooms.**



**Sealed installation means that the product is certified as sealed and its installation (ducting of the combustion air and connection to the chimney) is airtight with respect to the installation environment.**

A sealed installation does not consume the room's oxygen because it draws all the air from the outer environment (if suitably ducted) and makes it possible to install the product in all houses that require a high degree of insulation such as "passive" or "high energy efficiency" houses. Thanks to this technology there is no risk of smoke emissions in the room and no air inlets - hence not even the relevant ventilation grilles - are required in the installation premises.

Consequently, there will be more draughts of cold air in the room, thus making it more comfortable and increasing the overall efficiency of the system. The sealed stove in a sealed installation is compatible with the presence of forced ventilation or premises that might have negative pressure with respect to the outside.

## 6.2 MINIMUM DISTANCES

Observe the distances from flammable objects (sofas, furniture, wood panelling, etc..) as specified in the following diagram. If objects considered to be particularly sensitive to heat are present, such as furniture, curtains or sofas, as a precaution, increase the stove clearances substantially to avoid possible deterioration due to the effect of heat.

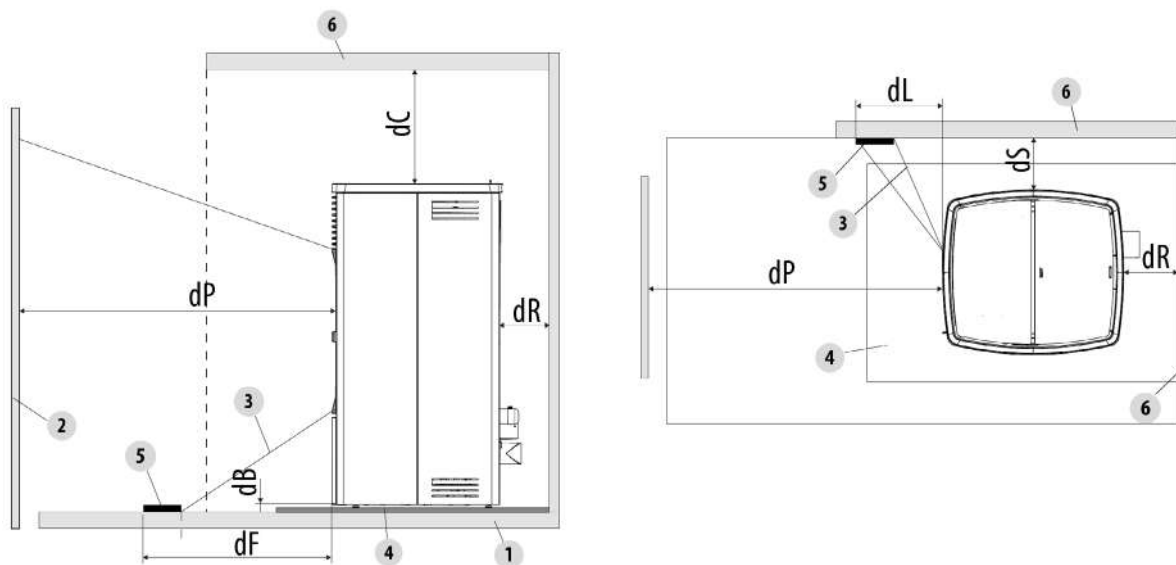


Fig. 13 - Safety distance from combustible material

LEGEND	Fig. 13
<b>dR (rear distance)</b>	50 mm
<b>dS (side distance)</b>	200 mm
<b>dB (lower distance)</b>	0 mm
<b>dC (upper distance)</b>	750 mm
<b>dP (front radiation)</b>	1000 mm
<b>dF (floor radiation)</b>	1000 mm
<b>dL (side radiation)</b>	1000 mm
<b>1</b>	Floor
<b>2</b>	Front flammable material
<b>3</b>	Area subject to radiation
<b>4</b>	Floor guard
<b>5</b>	Radiated surface to be protected
<b>6</b>	Rear/side/upper flammable surface

If the floor is made of combustible material, use a protection made of non-combustible material (steel, glass...) that also protects the front from any falling combusted material during cleaning operations.



**Always fit a floor guard if the floor is made of flammable material.**

Install the stove also detached from any non-combustible walls/surfaces, observing a minimum clearance of **50 mm** (back) and **200 mm** (side) to allow effective aeration of the appliance and a good distribution of heat in the room.

In any case, ensure adequate distance to facilitate access during cleaning and extraordinary maintenance. If this is not possible, it must still be possible to distance the product from adjacent walls/elements.

This operation (\*\*) must be performed by a technician qualified to disconnect the combustion product expulsion ducts and their subsequent restoration.

For generators connected to the hydraulic system, a connection must be provided between the system itself and the product so that, during extraordinary maintenance, carried out by a qualified technician, it is possible to move the generator 1 by at least 50 cm from adjacent walls without emptying the system (e.g. by using a double shut-off gate or suitable flexible connection).

(\*\*) *The national reference standard for the installation of domestic appliances is UNI 10683 (IT) - DTU NF 24.1 (FR) - DIN 18896 (DE) - NBN B 61-002 (BE) - Real Decreto 1027/2007 (ES) Paesi Bassi (NL) Bouwbesluit - Danmark (DK) BEK n° 541 del 27/04/2020.*

### 6.3 INSULATING MATERIAL

The probable insulating material to use must have the following technical features:

DESCRIPTION		VALUE
Material thickness		40 mm
Screening temperature		1000 °C
Density		245 Kg/m <sup>3</sup>
Shrinkage at referring temperature (12h)		1,3 % /1000 °C
Cold crushing strenght		1,4 MPa
Bending strenght		0,5 MPa
Thermal expansion coefficient		5,4x10 <sup>-6</sup> m/mK
Specific heat		1,03 Kj/kgK
Thermal conductivity at medium temperature	200 °C	0,07 W/mK
	400 °C	0,10 W/mK
	600 °C	0,14 W/mK
	800 °C	0,17 W/mK

## 6.4 OVERALL DIMENSIONS

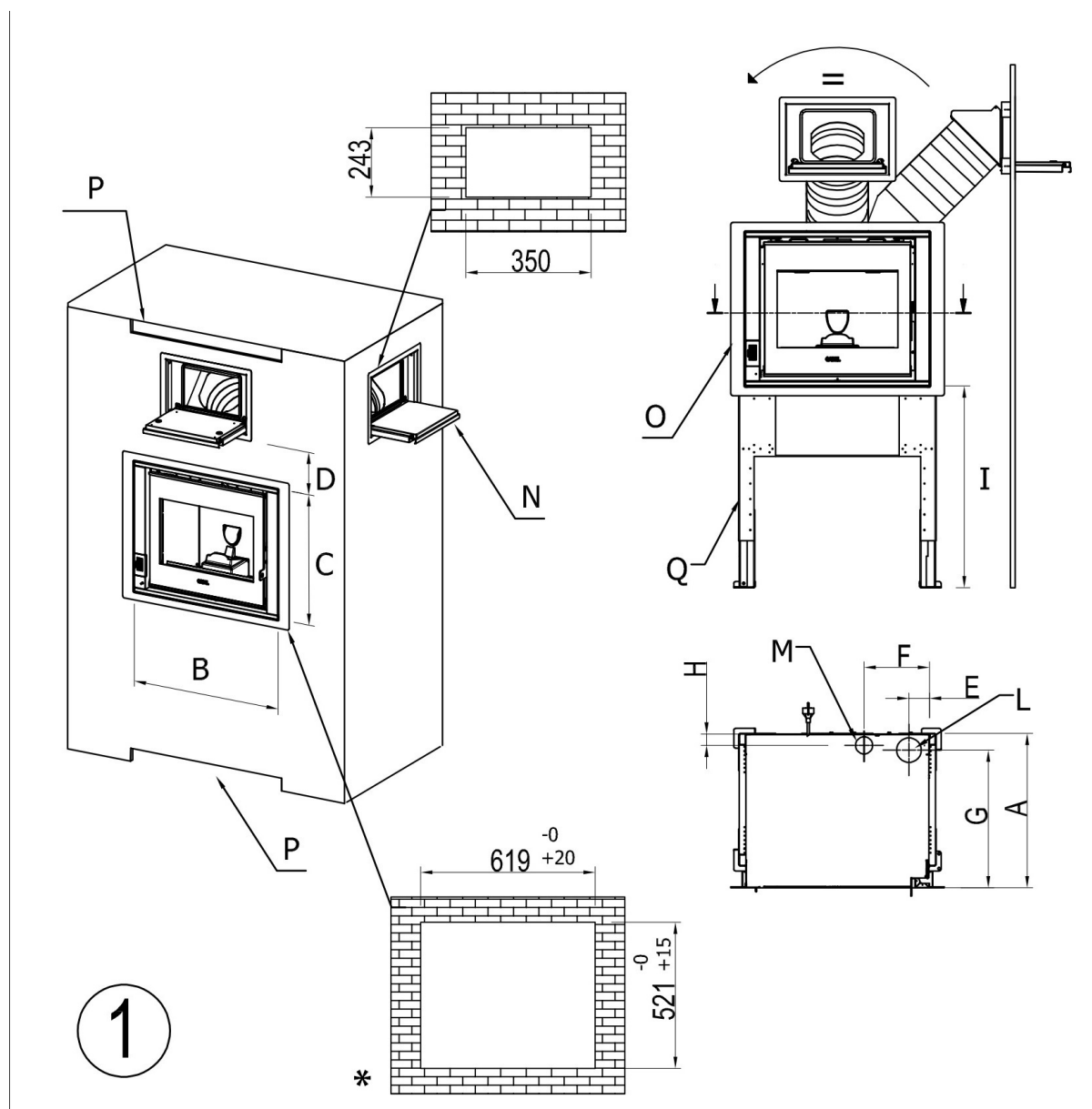
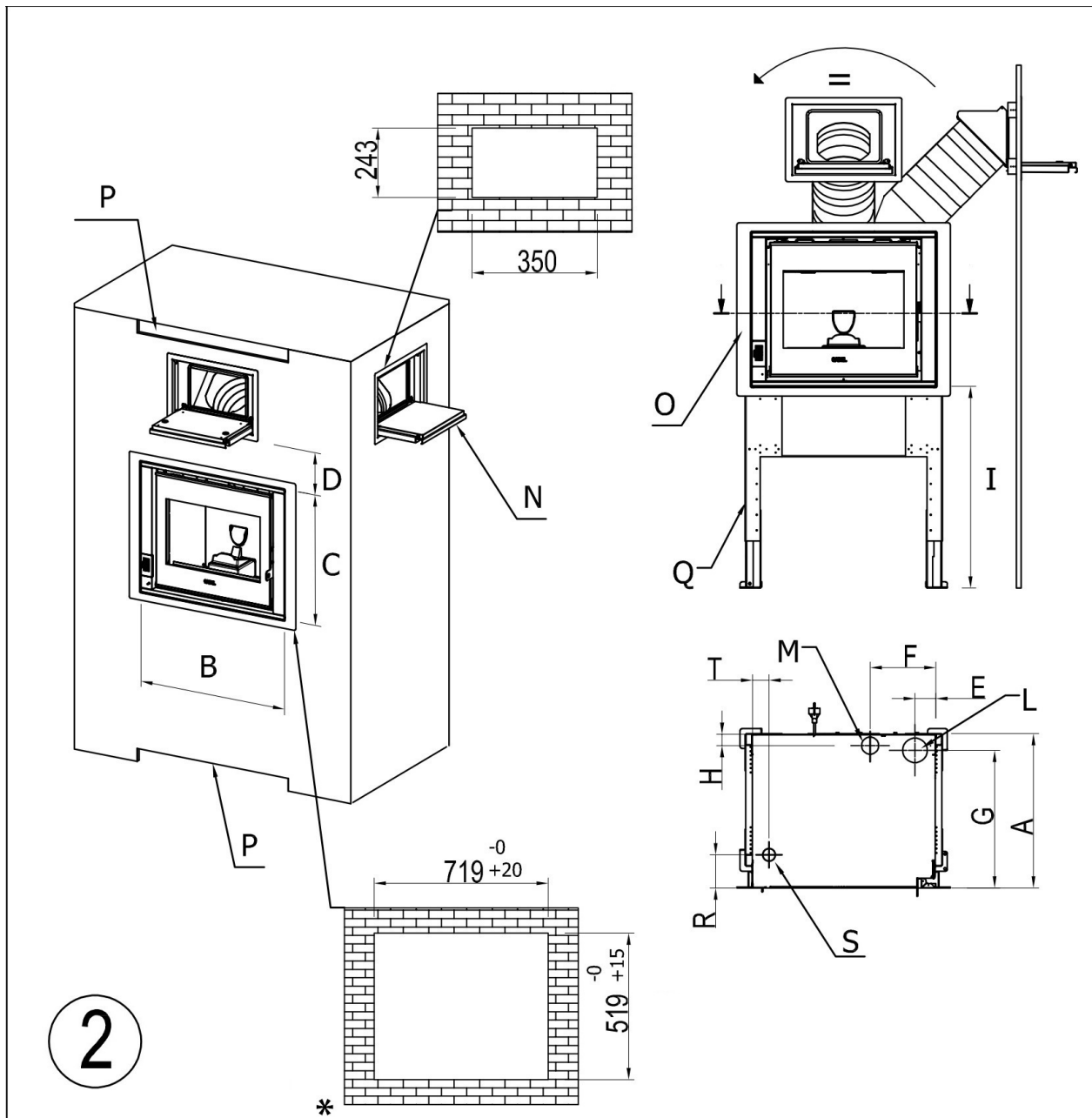


Fig. 14 - PONENTE - ZENITH with loadingdoor + frame

\* **FRAME HOLE** (optional): Without frame, provide 1 hole slightly larger than the size of the machine. B+C

LEGEND	Fig. 14		
A	501	L	Exhaust fumes $\varnothing$ .8 cm
B	597	M	Hole combustion air inlet $\varnothing$ .6 cm
C	503	N	Kit loading door: cod. 5018002 (optional)
D	170 ÷ 270	O	Kit PONENTE frame Kit with loading door: cod. 5024003 (optional)
E	70	P	Upper/Lower ventilation holes
F	213	Q	Basic Kit: cod. 5024009 (optional)
G	447	R	n/a
H	39	S	n/a
I	500 ÷ 650	T	n/a

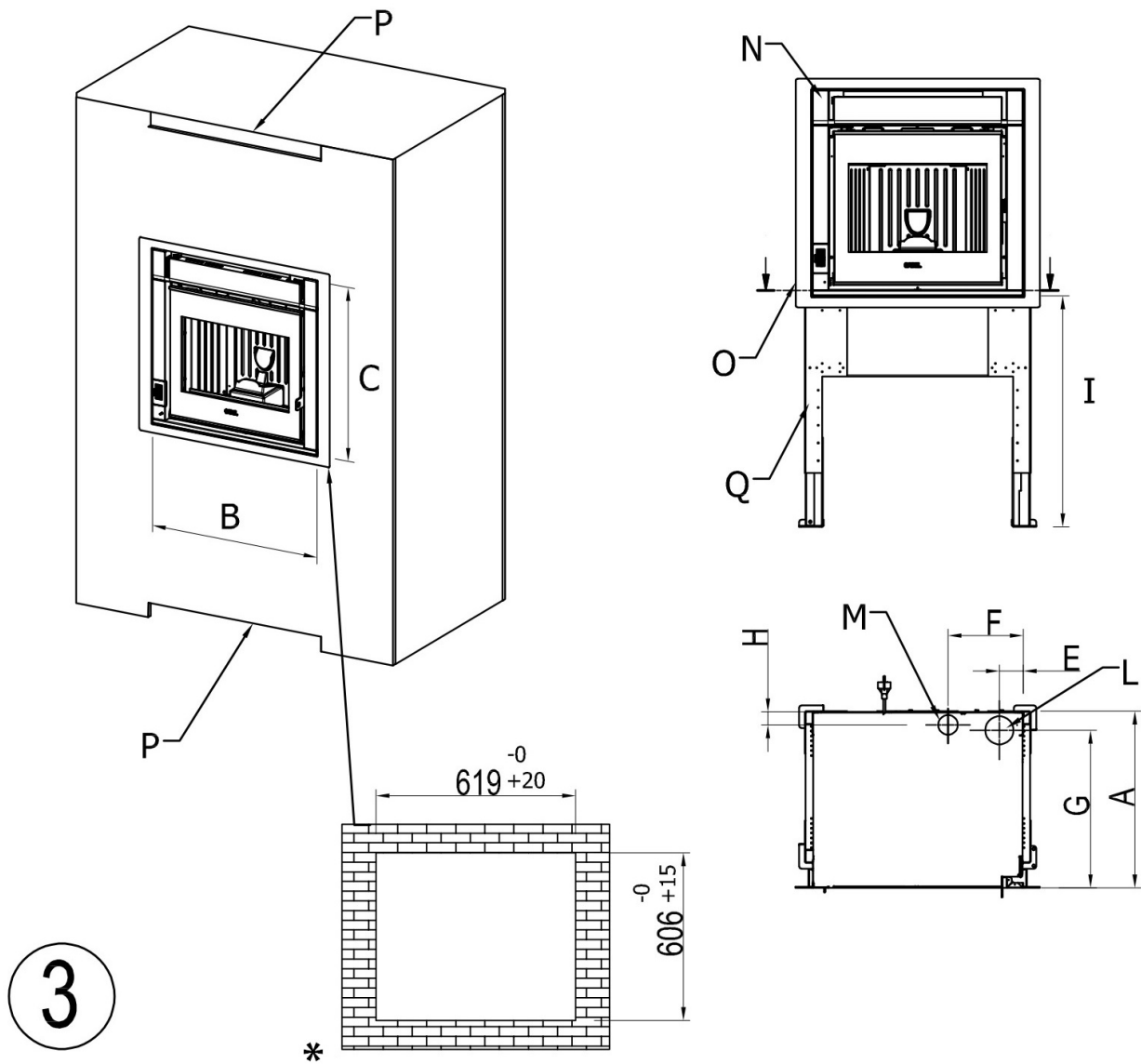


2

Fig. 15 - ZEN - ZEFIRO with loadingdoor + frame

\* **FRAME HOLE** (optional): Without frame, provide 1 hole slightly larger than the size of the machine. B+C

LEGEND	Fig. 15		
A	550	L	Exhaust fumes Ø.8 cm
B	697	M	Hole combustion air inlet Ø.6 cm
C	502	N	Loading door Kit : cod. 5018002 (optional)
D	170 ÷ 270	O	ZEN-ZEFIRO frame Kit with loading door: cod. 5018006 (optional)
E	61	P	Upper/Lower ventilation holes
F	258	Q	Basic Kit: cod. 5024009 (optional)
G	494	R	177
H	37	S	Ducting outlet d.8 cm cod. 5018005 (Optional)
I	500÷650	T	62



**Fig. 16 - PONENTE - ZENITH drawer + frame**

\* **FRAME HOLE** (optional): Without frame, provide 1 hole slightly larger than the size of the machine. B+C

LEGEND		Fig. 16	
<b>A</b>	501	<b>L</b>	Exhaust fumes $\varnothing$ .8 cm
<b>B</b>	597	<b>M</b>	Hole combustion air inlet $\varnothing$ .6 cm
<b>C</b>	503	<b>N</b>	PONENTE drawer Kit: cod. 5024002 (optional)
<b>D</b>	n/a	<b>O</b>	PONENTE frame Kit with Drawer: cod. 5024004 (optional)
<b>E</b>	70	<b>P</b>	Upper/Lower ventilation holes
<b>F</b>	213	<b>Q</b>	Basic Kit: cod. 5024009 (optional)
<b>G</b>	447	<b>R</b>	n/a
<b>H</b>	39	<b>S</b>	n/a
<b>I</b>	500÷650	<b>T</b>	n/a

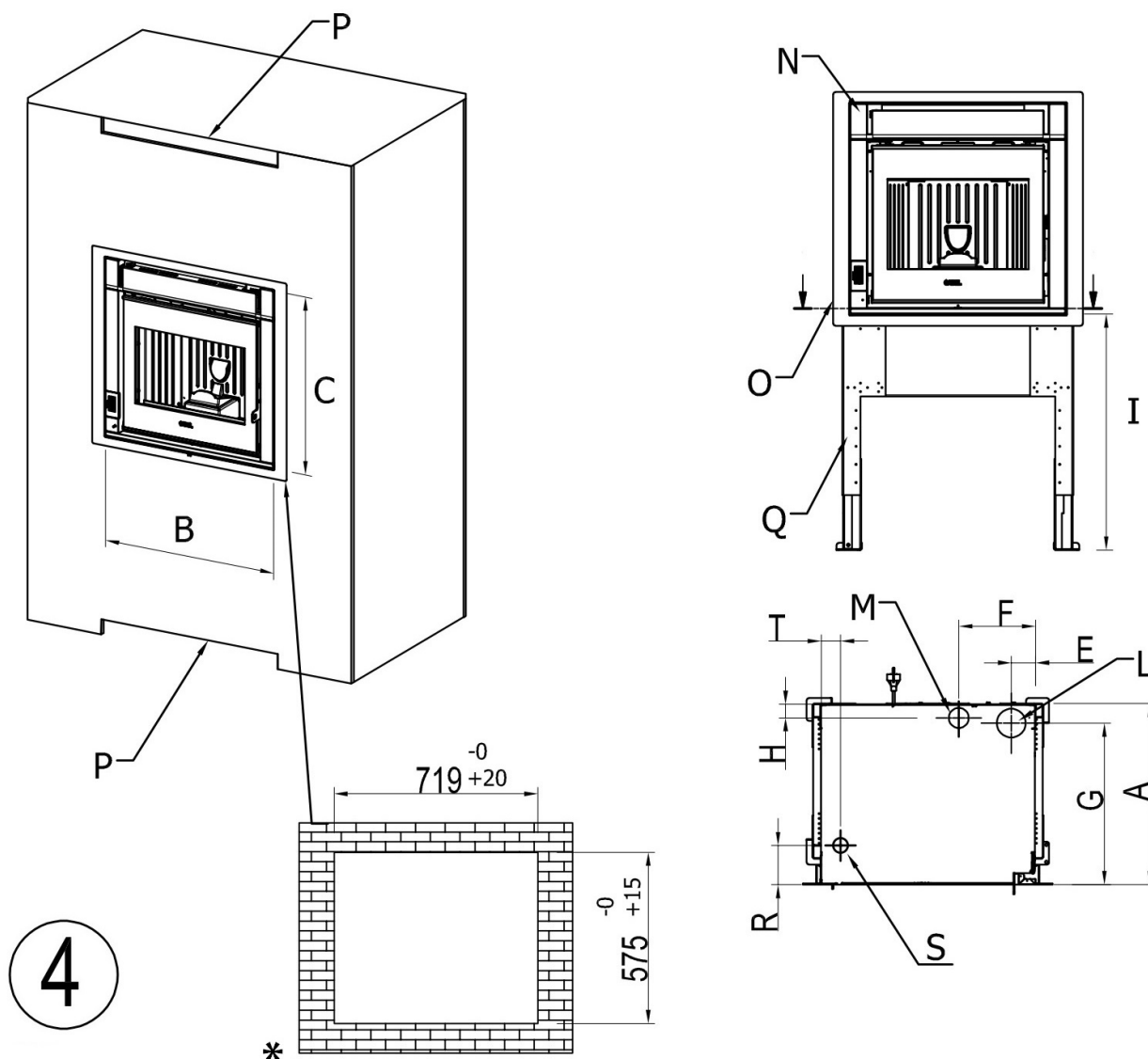


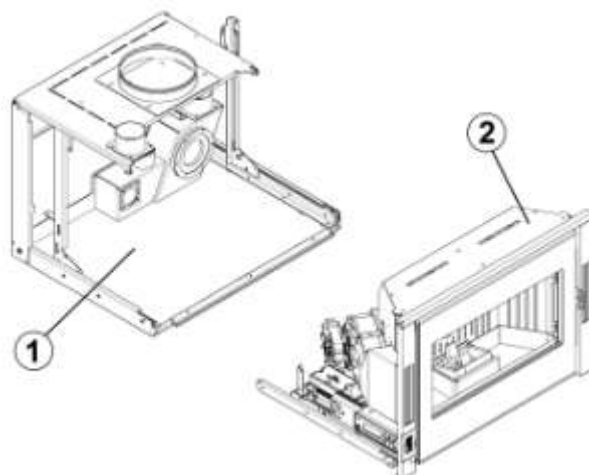
Fig. 17 - ZEFIRO-ZEN drawer + frame

\* **FRAME HOLE** (optional): Without frame, provide 1 hole slightly larger than the size of the machine. B+C

LEGENDA	Fig. 17		
A	550	L	Exhaust fumes Ø.8 cm
B	697	M	Hole combustion air inlet Ø.6 cm
C	556	N	ZEN-ZEFIRO drawer Kit: cod. 5018001 (optional)
D	n/a	O	ZEN-ZEFIRO frame Kit with Drawer: cod. 5018007 (optional)
E	61	P	Upper/Lower ventilation holes
F	258	Q	Basic Kit: cod. 5024009 (optional)
G	494	R	177
H	37	S	Ducting outlet d.8 cm cod. 5018005 (Optional)
I	500÷650	T	62

## 6.5 INSERT EXTRACTION

The insert is composed of:



**Fig. 18 - Structure + machine body**

Key	Fig. 18
1	Structure
2	Machine body

Proceed as follows to extract the insert:

- Open the door.
- Lift the hook (vedi **Fig. 19**) and pull the machine body firmly towards you (see **Fig. 20**).
- Once the machine body has been extracted, you can access the pellet tank.



**Fig. 19 - Lift hook**



**Fig. 20 - Machine body extraction**

## 6.6 INSERT REMOVAL



*If the insert is inserted on the guides, there is a danger of tipping over!*



*Assembly operations must always be carried out by 2 people!*

- Pull out the machine body from the structure (see **INSERT EXTRACTION a pag. 17**).
- Loosen the 2 hex screws on both sides of the insert (see **Fig. 21**).
- Lift the safety plate locking the guide open (see **Fig. 22**).



**Fig. 21 - Loosen screws**



**Fig. 22 - Lift locking plate**

- Using the supplied handles (see **Fig. 23**) place them in the appropriate seats (see **Fig. 24**) and remove the machine body from the guides.
- To reassemble it proceed in reverse order.



**Fig. 23 - Handle**



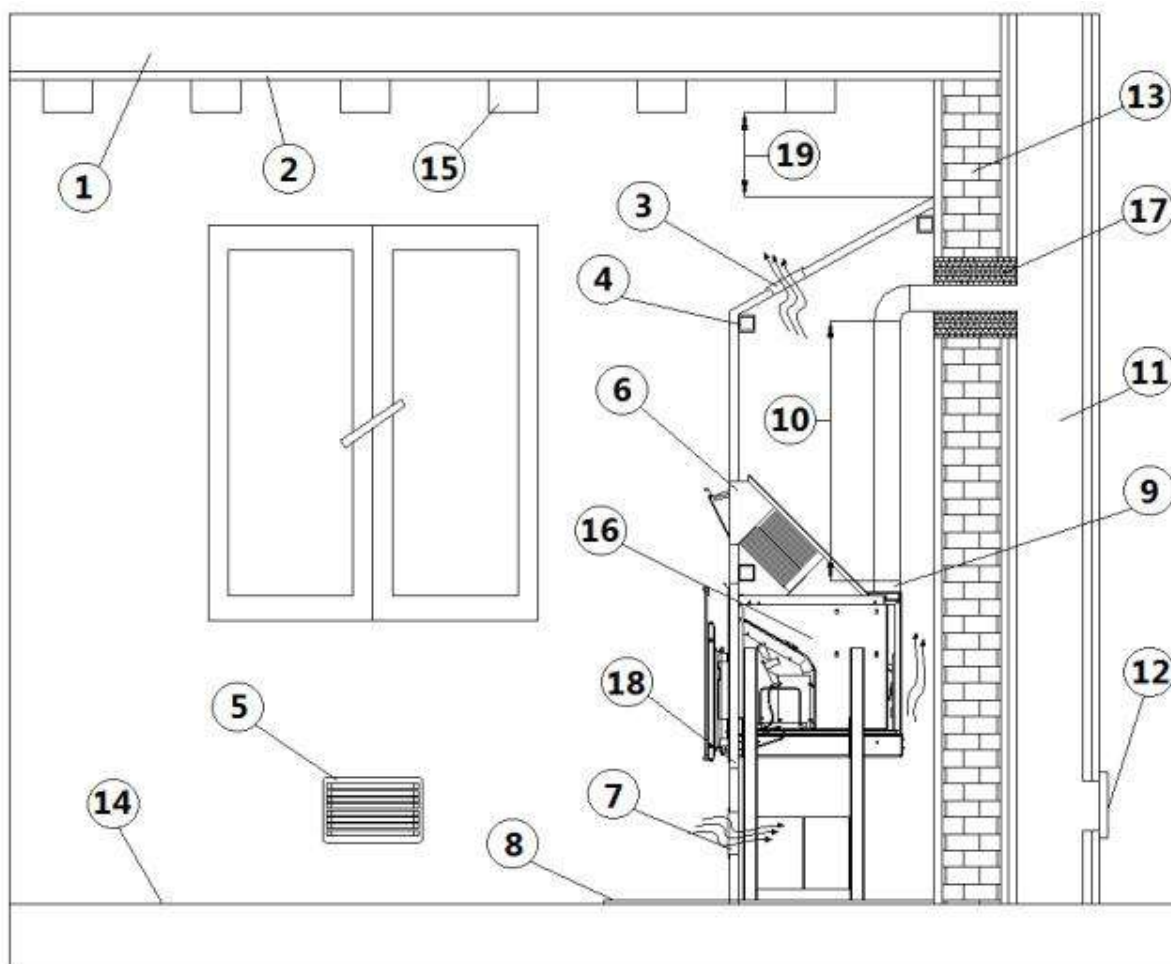
**Fig. 24 - Machine body removal**

## 6.7 INSTALLATION WITH EXTERNAL COVER

- It is possible to cover the insert with your liking cover respecting the correct execution as described in **MINIMUM DISTANCES a pag. 11** and following the under mentioned instructions.
- Fix the legs (optional) to the floor and lift the insert frame till the desired height by adjusting the legs and then block it with screws on the fitting guides.
- It is obligatory to fix the supporting frame legs at the base with metal plugs able to bear a weight of 50 kg for leg.



*In case of insert extraction fixed on guides there is the risk of overturning!  
Check if the insert frame is fixed to the floor.*



**Fig. 25 - Installation with cover**

LEGEND	Fig. 25
1	Ceiling to protect
2	Ceiling plaster to protect from heat
3	Ventilation grid with a minimum entrance of 400 cm <sup>2</sup> for natural hot convective air outlet
4	Self-supporting metal frame
5	Combustible air outlet
6	Pellet load entrance
7	Lower air grid with a minimum entrance of 400 cm <sup>2</sup> for natural cool convective air inlet
8	Floor protecting plate
9	Outlet clutch Ø80 mm
10	Fume pipe Ø80 mm with a minimum vertical length of 1 mt
11	Chimney flue of minimum Ø120 mm
12	Sealed chimney flue's inspection door
13	Wall
14	Floor
15	Ceiling with wooden beam
16	Fireplace insert
17	Insulating between wall and fume pipe of minimum 200 mm on the whole diameter
18	Combustible air inlet
19	Minimum distance between the wooden beams and the fume pipe = 0,5 mt

- Build a metal frame for supporting cover panels (4).
- Do not discharge the metal structure weight on the insert frame.
- Cover the metal frame with panels made up of no flammable materials.



*Made a cleft of min. 400 cm<sup>2</sup> on the lower (7) and upper (3) parts of the panels for the inner air recycling.*

- The pellet loading can occur by extracting the insert at switched off appliance, otherwise through the installation of a loading trap door (6).
- The loading trap door can be frontally or laterally installed, extending the flexible pipe Ø160 mm according to your needs.

## 6.8 INSTALLATION ON EXISTING FIREPLACE

- It is possible to build the insert into an existing fireplace respecting the distances and the correct execution as described by **MINIMUM DISTANCES a pag. 11** and following the below mentioned instructions.
- It is obligatory to fix the supporting frame at the base with metal plugs able to bear a weight of 50 kg for leg.



*In case of fixed on guides insert extraction there is the risk of overturning!  
Check if the insert frame is correctly fixed to the base.*

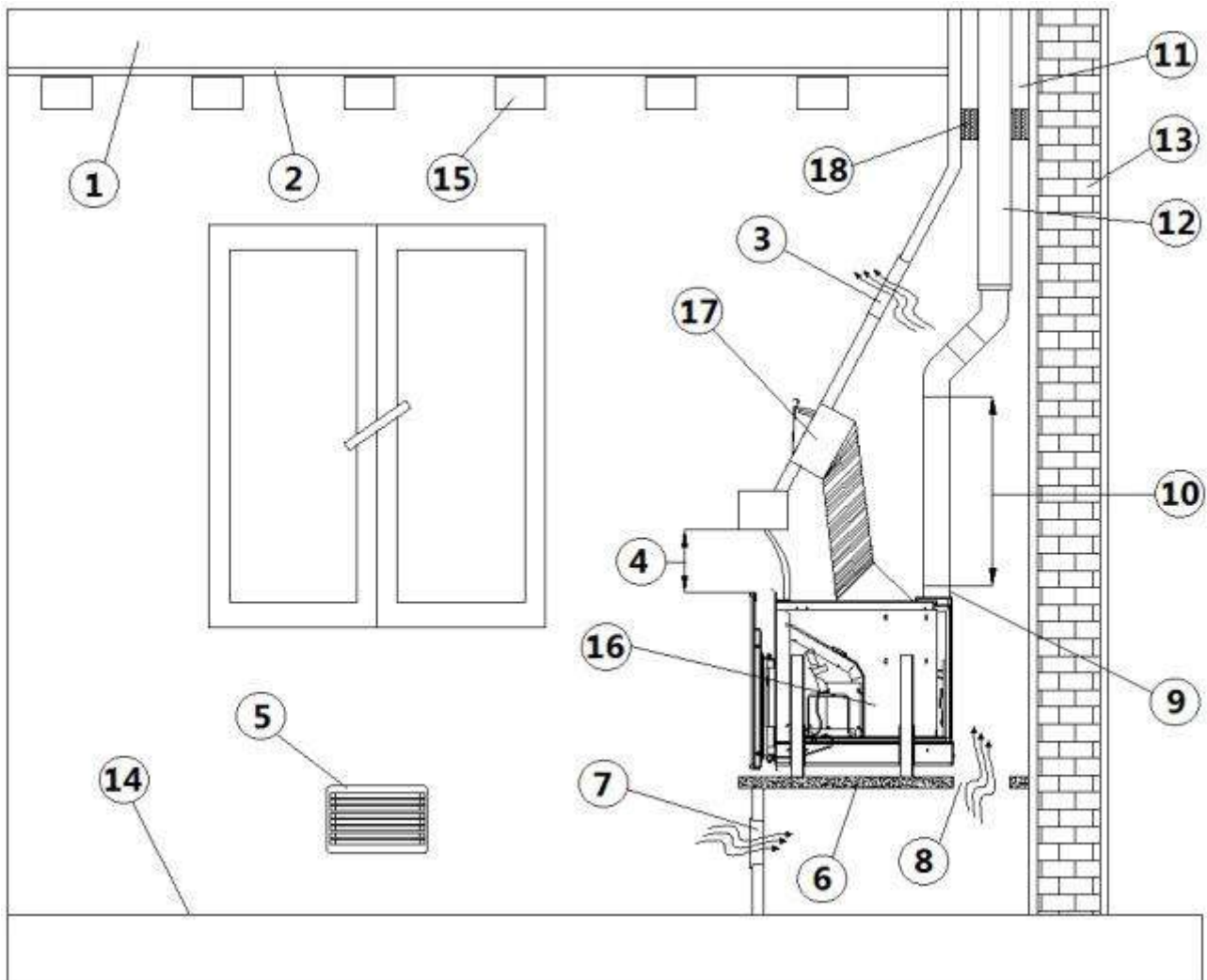


*Check if the upper hot air outlet is not choked, see **Fig. 26**.*



*Make a cleft of 400 cm<sup>2</sup> on the lower and upper part of the fireplace for the inner air recycling.*

- The pellet loading can occur by extracting the insert at switched off appliance, otherwise through the installation of a loading trap door (6).
- The loading trap door can be frontally or laterally installed, extending the flexible pipe Ø160 mm according to your needs.



**Fig. 26 - Installation on the existing fireplace**

**LEGEND Fig. 26**

<b>1</b>	<i>Ceiling to protect</i>
<b>2</b>	<i>Ceiling plaster to protect from heat</i>
<b>3</b>	<i>Ventilation upper grid minimum entrance 400 cm<sup>2</sup> for natural hot convective air outlet</i>
<b>4</b>	<i>Minimum distance from flammable material 10 cm</i>
<b>5</b>	<i>Combustible air inlet</i>
<b>6</b>	<i>Fireplace's fire plate</i>
<b>7</b>	<i>Lower air grid with minimum entrance 400 cm<sup>2</sup> for natural cool convective air inlet</i>
<b>8</b>	<i>Ventilation cleft of 400 cm<sup>2</sup> for convective cool air recycling</i>
<b>9</b>	<i>Outlet clutch Ø80 mm</i>
<b>10</b>	<i>Fume pipe Ø80 mm with minimum vertical lenght of 1 mt</i>
<b>11</b>	<i>Chimney flue &gt; Ø120 mm</i>
<b>12</b>	<i>Fume pipe Ø100 mm</i>
<b>13</b>	<i>Wall</i>
<b>14</b>	<i>Floor</i>
<b>15</b>	<i>Ceiling with wooden beams with a minimum distance from the fume pipe = 0,5 mt</i>
<b>16</b>	<i>Fire place insert</i>
<b>17</b>	<i>Pellet loading entrance</i>
<b>18</b>	<i>Locking ring</i>

## 6.9 DOOR ADJUSTMENT (ZEN - ZEFIRO)

To centre the door, proceed as follows:

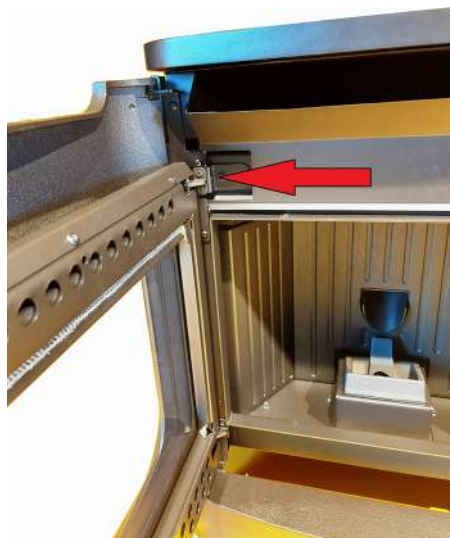


*Fig. 27 - Door adjustment*

- Open the door.
- Loosen the two front screws in the upper hinge and, using the side screw (the one circled in the picture) adjust the door forward or backward (see **Fig. 27**).
- Once the door is centred, lock the 2 front screws.

## 6.10 DOOR ADJUSTMENT (PONENTE - ZENITH)

To centre the door, proceed as follows:



*Fig. 28 - Door adjustment*

- Open the door.
- Loosen the two front screws in the upper hinge and, using the side screw (the one circled in the picture) adjust the door forward or backward (see **Fig. 28**).
- Once the door is centred, lock the 2 front screws.

## 6.11 CONNECTION TO THE EXTERNAL THERMOSTAT

The stove is already working by means of a thermostat probe positioned inside it.

We strongly recommend connecting the insert to an external thermostat, as the room probe may not work properly in the presence of high temperatures (given the close distance to the combustion chamber, see **Fig. 29**).

This operation must be performed by an authorised technician.



**Fig. 29 - Thermostat probe**

Connect the wires from the external thermostat to the "Term opt" terminal on the stove board. Activate the external thermostat (default setting OFF) as indicated below:

- Press the "menu" button.
- Scroll with the arrows to "Settings".
- Select by pressing "menu".
- Scroll with the arrows again to "Ext.Thermostat".
- Select by pressing "menu".
- Press the - + buttons.
- To activate the external thermostat select "on".
- Press the "menu" button to confirm.

## 6.12 ELECTRIC CONNECTION



*Warning: the appliance must be installed by an authorized technician!*

- The electric connection occurs through a cable with plug put in an electric socket which is able to support charge and tension specific of every model, as described in the technical datas table (see **FEATURES a pag. 42**).
- The plug must be easily accessible when the appliance is installed.
- Please further assure you that your network is endowed with an efficient earth connection: if it does not exist or if it is not efficient, please endow you with one in compliance with the law.
- Connect the supply cable first on the back of the stove (see **Fig. 30** and **Fig. 31**) and then at a wall electric socket.



**Fig. 30 - Electric socket with master switch**



**Fig. 31 - Plug connected**

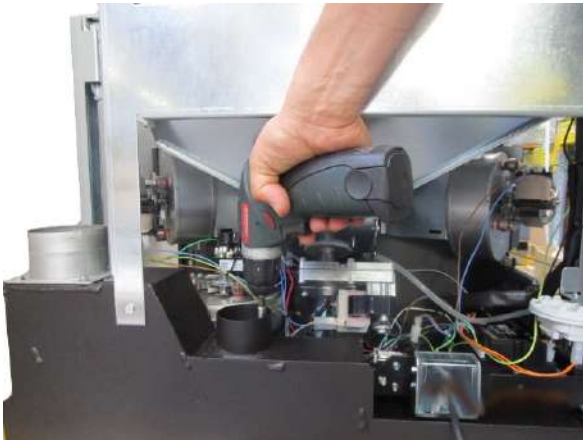
- Do not use extension cables.
- If the feeder cable is damaged, it must be replaced by an authorized technician.
- When the stove is not going to be used for a long period of time, it advisable to remove the plug from the socket on the wall.
- An electrical connection to a UPS/ACCUMULATOR/ STABILISER must guarantee a voltage of at least 210 V without power surges. Considering the variety of UPS on the market regarding size and construction qualities, we cannot guarantee operation once the stove is connected to these devices.

## 6.13 AIR REGULATOR

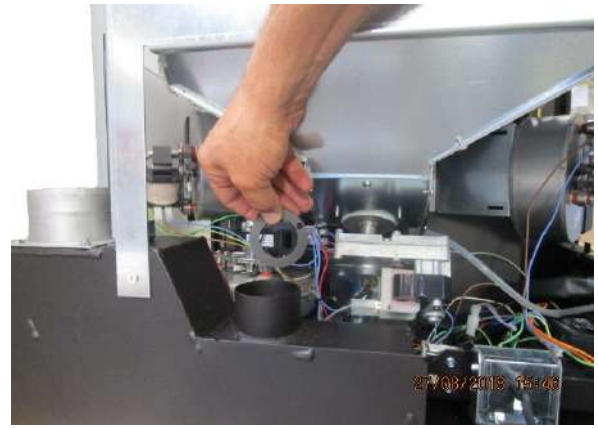
The stove is fitted with a removable rear air regulator

The stove is regulated according to the flue data and pellet used, as per the technical features (see **FEATURES a pag. 42**)

If the data does not match, the authorised technician can increase the stove draft by removing/loosening the ring located inside the air inlet pipe (see **Fig. 32** and **Fig. 33**).



**Fig. 32 - Ring removal 1**



**Fig. 33 - Ring removal 2**

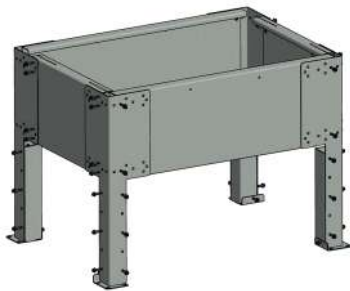
Air regulator opening 35 mm for nominal power with flue 11 Pa.

## 6.14 INSERT LEGS INSTALLATION (OPTIONAL)

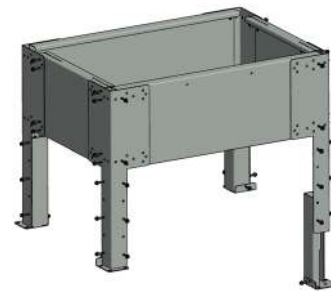
It is possible to install the insert on a support structure with height-adjustable legs.

To assemble the legs, proceed as follows:

- Compose the 4 legs and fix them with the screws (see **Fig. 34**).
- Fix the leg reinforcement with the extension using the screws (see **Fig. 35**).

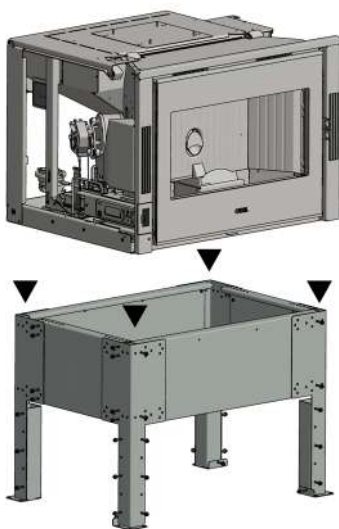


**Fig. 34 - Assemble legs**

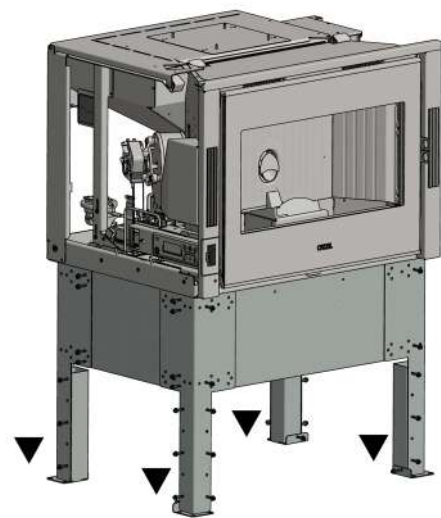


**Fig. 35 - Assemble reinforcement + extension**

- Place the insert above the structure, fixing it with the screws in the appropriate seats (see **Fig. 35**).
- Position the structure with the insert as desired and fix the legs to the floor and the extensions to the wall behind (see **Fig. 37**).



**Fig. 36 - Fix insert above**



**Fig. 37 - Fix the structure to the floor and wall**

## 6.15 HOT AIR DUCTING (OPTIONAL ONLY FOR ZEFIRO)



WITH THE INSTALLATION OF THE DUCTING, IT IS NECESSARY TO LOAD THE NEW DATABASE IN THE BOARD (DATABASE NO.02).  
SEE "SERVICE MANUAL".

By default, the insert inserts the hot air into the environment from both the front vents. It is possible to channel the left air on the back of the stove, through a ducting kit.

To assemble the kit, proceed as follows:

- Extract the machine body.
- Remove the 4 fixing screws of the left fan (see **Fig. 38**).
- Use a clamp to break the corner of the casing (see **Fig. 39**) and bend the flap inwards with your hands (see **Fig. 40**).



**Fig. 38 - Remove the fan**



**Fig. 39 - Break the corner**

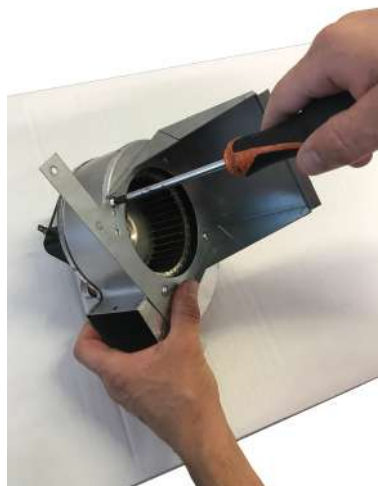


**Fig. 40 - Fold the flap**

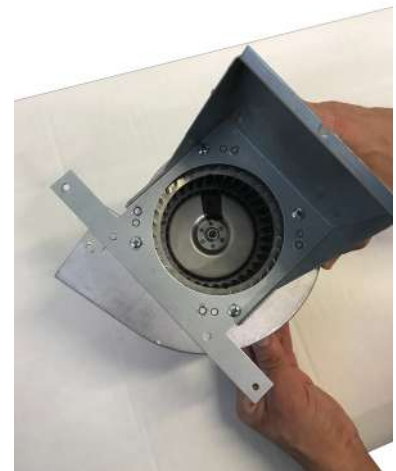
- Place the fan and casing on a surface (see **Fig. 41**).
- Loosen the 4 screws (see **Fig. 42**) and rotate the casing and retighten the screws in the new position. Pay attention to the position of the holes (see **Fig. 43**).



**Fig. 41 - Fan + casing**



**Fig. 42 - Remove the screws**



**Fig. 43 - Rotate the fan**

- Insert the air diverter temporarily as shown in the picture **Fig. 44**.
- Fit the new fan + casing in the new position and secure the screws (see **Fig. 45**).
- Then align the diverter with the holes in the boiler. Attention: the air diverter must protrude about 16 mm above the machine body (see **Fig. 46**).



**Fig. 44 - Position the air diverter**



**Fig. 45 - Secure the fan**



**Fig. 46 - Projection of the air diverter**

- Seal the joint between the fan and the diverter with adhesive aluminium tape (see **Fig. 47**).
- Mount the fitting on the air diverter for the air to be ducted (see **Fig. 48**).
- Connect the ducting pipe d.80 and block the pipe with the clamp. Attention: use at least 20 cm of flexible pipe above the fitting since the cover of the insert moves during manoeuvres (see **Fig. 49**).



**Fig. 47 - Seal with adhesive aluminium tape**



**Fig. 48 - Secure the fitting**



**Fig. 49 - Flexible pipe connection (rear view of the insert)**



**Fig. 50 - Example of ducting**

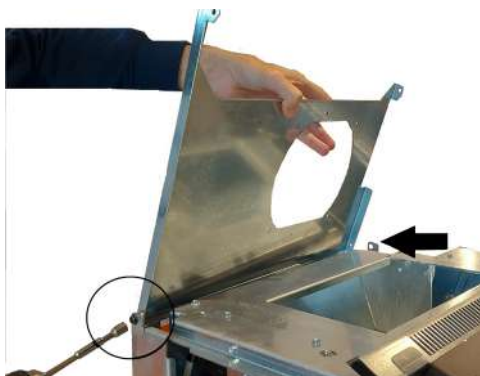
- A stove with no ducting has a variable air flow rate from a minimum of 61 m<sup>3</sup>/h to a maximum of 130 m<sup>3</sup>/h, and an air temperature which varies from a minimum of 90°C to a maximum of 136°C.
- In the case of ducting, it is recommended not to exceed 6 metres of pipe and 3 x 90° bends, otherwise the hot air loses its effectiveness.
- Use pipes with an 80 mm diameter with smooth internal walls.
- If the pipes pass through cold walls, insulate the pipe with insulating material.
- Place a protective grille with large mesh and a total minimum net surface area of 40 cm<sup>2</sup> over the outlet.
- After the 6 metres of pipe there can be a variable air flow rate from a minimum of 58 m<sup>3</sup>/h to a maximum of 83 m<sup>3</sup>/h, and an air temperature which varies from a minimum of 65°C to a maximum of 99°C. (These values have been recorded in the laboratory, there may be differences in both flow rate and temperature in the installation room).
- If you wish to increase the air flow, install a small wall-mounted fan on the outlet with a flow rate of more than 130 m<sup>3</sup>/h, this should be performed by an authorised technician.
- With factory parameters 1/2 of the heat produced by the stove is conveyed into the room where it is installed, the remaining 1/2 comes out from the ducting on the left.
- To get the best performance you need to balance the power with the air flow. This operation must be performed with the assistance of an authorised technician.
- The ductable fans cannot be deactivated, but they can be operated at a power value between 1 and 5 or in automatic mode.

## 6.16 PELLET DRAWER INSTALLATION (OPTIONAL)

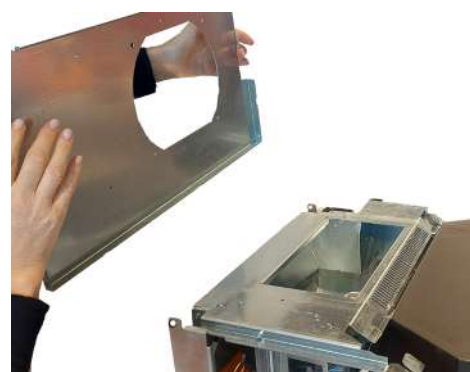
The insert is designed for loading the pellet through a drawer.

Proceed as follows to assemble:

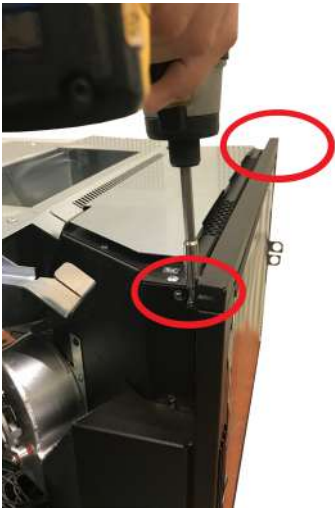
Remove the top cover completely (see **Fig. 51 Fig. 52**).



**Fig. 51 - Top removal 1**



**Fig. 52 - Top removal 2**



**Fig. 53 - Upper profile removal**



**Fig. 54 - Gasket removal**



**Fig. 55 - Gasket positioning**

- Remove the insert from the machine body.
- Remove the upper profile above the door (see **Fig. 53**).
- In the structure, remove the silicone gasket under the cover (see **Fig. 54**) and place it under the pellet loading drawer (see **Fig. 55**).



**Fig. 56 - Drawer positioning**



**Fig. 57 - Drawer front fixing**



**Fig. 58 - Drawer central fixing**

- Position the drawer above the machine body (see **Fig. 56**) and fix the front part first (see **Fig. 57**) then the central part (see **Fig. 58**).



**Fig. 59 - Adjustment for centring**

- If necessary, remove the drawer and adjust, using the 2 wheels on the guides, its centring (see **Fig. 59**).

## INSERT WITH DRAWER WITHOUT DUCTING



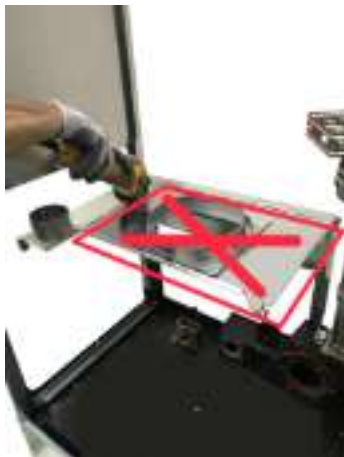
**Fig. 60 - Remove the cover**



**Fig. 61 - Insert insertion**

- Completely remove the cover from the structure (see **Fig. 60**).
- Position the machine body with the pellet drawer in the structure (see **Fig. 61**).

### INSERT WITH DRAWER AND WITH DUCTING



**Fig. 62 - Cover cut**



**Fig. 63 - Insert insertion**

- Following the precuts, cut the indicated part using an angle grinder/hacksaw (see **Fig. 62**) and then remove it.
- Position the machine body with the pellet drawer in the structure (see **Fig. 63**) and proceed with the connection of the air ducting pipe (see dedicated chapter).

### 6.17 TRAPDOOR INSTALLATION (OPTIONAL)

The insert is designed for loading the pellet through a trapdoor.

The hole in the wall where it will house the trapdoor must have the following dimensions:

**L = 34 cm**  
**H = 23,5 cm**

Proceed as follows to assemble:



**Fig. 64 - Fix the flexible hose**



**Fig. 65 - Tighten the clamp**



**Fig. 66 - Remove the cap**

- Fix the flexible hose to the trapdoor base (see **Fig. 64**) with the metal clamp (see **Fig. 65**).
- Remove the cap from the structure cover (see **Fig. 66**).



**Fig. 67 - Flexible hose positioning**



**Fig. 68 - Silicone the flange**



**Fig. 69 - Flexible hose fixing**

- Pass the flexible hose inside the hole made in the wall (see **Fig. 67**).
- Fix the pipe end flange to the structure cover, where the cap was previously removed (see **Fig. 68** and **Fig. 69**).



**Fig. 70 - Trapdoor external fixing**



**Fig. 71 - Trapdoor internal fixing**

- Fix the trapdoor to the door, both internally and externally (see **Fig. 70** and **Fig. 71**).



**Fig. 72 - Insert the door in the trapdoor**



**Fig. 73 - Correct hooking of the hinge**

- Hook the door to the trapdoor (see **Fig. 72**). **Make sure that the hinge is in the correct position** (see **Fig. 73**). (*in production until December 2022*)



**Fig. 74 - Safety lever**



**Fig. 75 - Door closed**

- Rotate the safety levers to lock the hinges (see **Fig. 62**).
- Close the door (see **Fig. 75**). The trapdoor is ready to be used.

## 6.18 FRAME INSTALLATION (OPTIONAL)

It is possible to insert a compensation/decorative frame around the insert. Proceed as follows to mount:



**Fig. 76 - Front fixing**



**Fig. 77 - Rear fixing 1**



**Fig. 78 - Rear fixing 2**

- Remove the insert from the structure.
- Loosen the 2 hex screws on the base of the structure, fit the frame and tighten the screws again (see **Fig. 76**).
- Fix the frame inside the wall using the supplied flange (see **Fig. 77** and **Fig. 78**).

- Insert the insert inside the structure again.

## 6.19 CONCENTRIC PIPE INSTALLATION

The insert is designed for the connection of the concentric pipe.  
Proceed as follows to assemble:

- Remove the ring inside the combustion air fitting (see **Fig. 79**).
- Insert the concentric pipe as in **Fig. 80**.



*Fig. 79 - Remove the ring*



*Fig. 80 - Concentric pipe connection + Combustion air*

## 6.20 DISPLAY ROTATION

By default, the display faces left.

Proceed as follows to have the display face right:



*Fig. 81 - Remove the display*



*Fig. 82 - Remove the flat cable*



*Fig. 83 - Remove the screws*

- Completely remove the door containing the display.
- Remove the display (see **Fig. 81**) and disconnect the flat cable to which it is connected (see **Fig. 82**).
- Remove the 2 screws from the display box (see **Fig. 83**).



**Fig. 84 - Rotate the display box**



**Fig. 85 - Secure the screws**



**Fig. 86 - Connect and reposition the display**

- Pull the display box back and turn it in the other direction (see **Fig. 84**).
- Fix the box in the new position (see **Fig. 85**).
- Reconnect the flat cable and reposition the display (see **Fig. 86**).

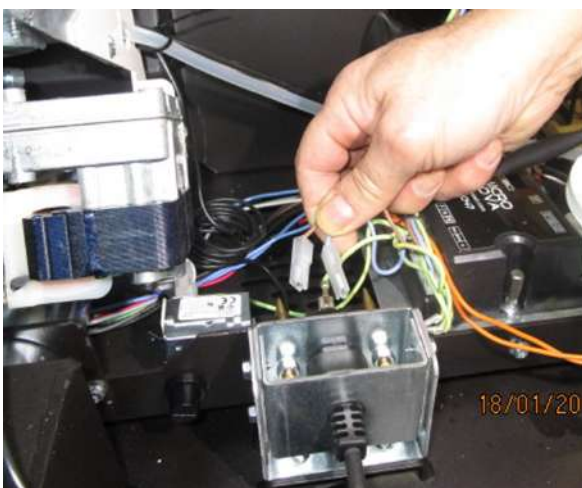
## 7 WI-FI KIT INSTALLATION

To install the WI-FI Kit, make the power supply cable with plug and faston (see **Fig. 87**)



**Fig. 87 - Plug + Faston**

Disconnect the power supply faston (blue - brown) connected directly to the socket and connect them on the double faston of the power supply cable. Reconnect everything to the main socket. (see **Fig. 88 Fig. 89**)



**Fig. 88 - Faston disconnection (blue - brown)**



**Fig. 89 - Double faston connection**

Fix the WI-FI module on the bottom of the tank with the power supply cable and the serial cable connected and lock the wi-fi module feeder on the strut with cable ties as shown. (see **Fig. 90**)



Fig. 90 - WI-FI module fixing

## 8 SPECIAL MAINTENANCE

### 8.1 INTRODUCTION

For a long working life of the stove, have a periodic cleaning of the stove as described in the following paragraphs.

- Fume outlet pipes (fume conduit + chimney flue + chimney pot) must always be cleaned, scrubbed and checked by an authorized technician in compliance with local regulations, with the instructions of the manufacturer and those of your insurance company.
- If there are no local regulations and no instruction from your insurance company, it is necessary to have your fume pipe, chimney flue and chimney pot cleaned at least once a year.
- It is also necessary to have the combustion chamber, motors and fans cleaned and to have the gaskets and the electrical elements checked at least once a year.



*All these operations must be planned in time with your Authorized Technical Assistance Service.*

- After a long ineffective time, before turning on the stove check if there are obstructions in the fume exhaust.
- If the stove had been using continuously and intensely, the whole system (chimney included), must be cleaned and checked more frequently.
- In case of replacement of damaged pieces please ask for the original spare part at the Authorized Retailer.

### 8.2 FEED SCREW MAINTENANCE

Proceed as follows for the feed screw maintenance:



Fig. 91 - Screw removal

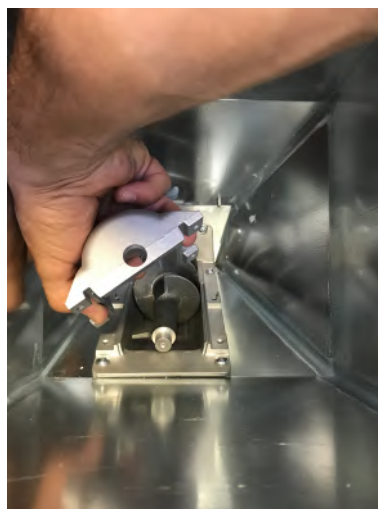


Fig. 92 - Coque removal



Fig. 93 - Gear motor removal

- Enter the tank and loosen the 4 screws of the feed screw coque (see Fig. 91).
- Remove the coque (see Fig. 92).
- Remove the gear motor by loosening the locking screw (see Fig. 93).



**Fig. 94 - Spiral removal**



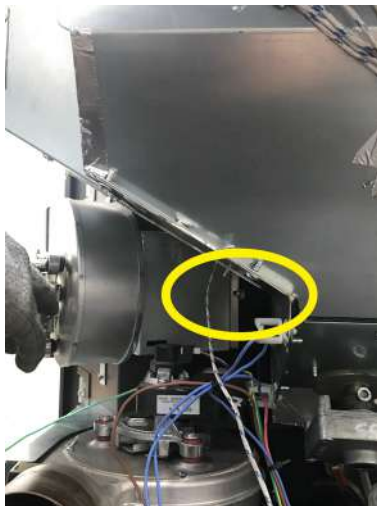
**Fig. 95 - Bearing removal**

- Remove the spiral (see **Fig. 94**).
- If worn, remove the bearing (see **Fig. 95**) and replace it.
- To reassemble, proceed in reverse order.

### 8.3 ROOM FAN CLEANING

Every year, clean the flue gas extractor to remove ash or dust causing unbalance of the blades and greater noise.

- Remove the insert and loosen the screw behind the right fan (see **Fig. 96**).
- Remove the front screws of the fan (see **Fig. 97** and **Fig. 98**).
- Disconnect the wiring and remove the fan (see **Fig. 99**).



**Fig. 96 - Loosen the screw**



**Fig. 97 - Remove screw 1**



**Fig. 98 - Remove screw 2**

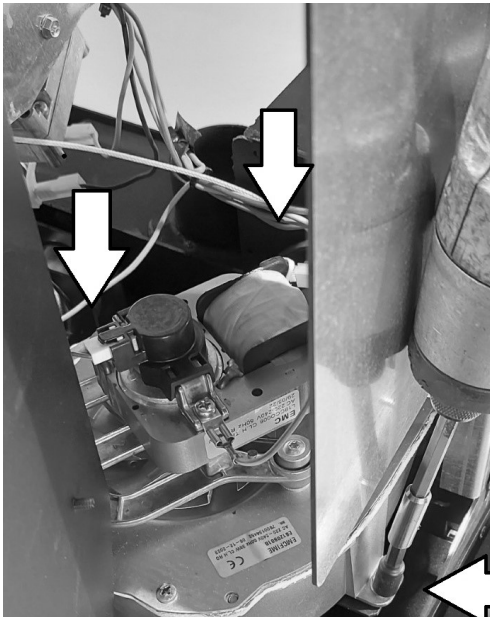


**Fig. 99 - Remove the fan**

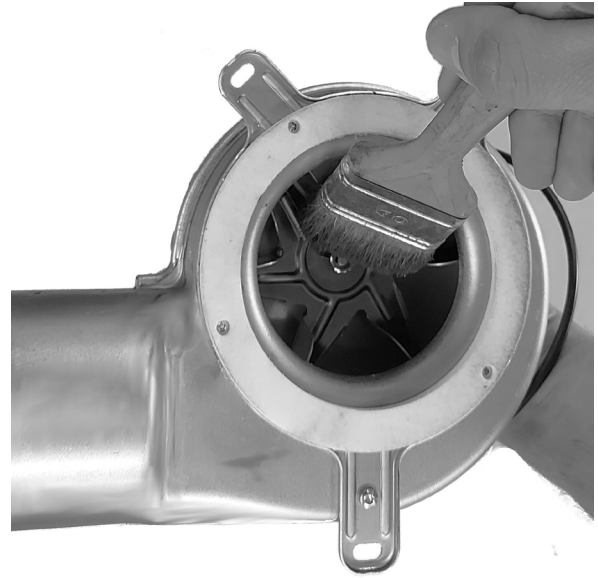
## 8.4 FLUE GAS EXTRACTOR CLEANING

Every year, clean the flue gas extractor to remove ash or dust causing unbalance of the blades and greater noise.

- Remove the flue gas extractor screws (see **Fig. 100**) and proceed with cleaning.



**Fig. 100 - Remove the screws, Cleaning 1**



**Fig. 101 - Cleaning 2**

- Clean with a brush and vacuum the soot inside (see **Fig. 101**).
- Once thoroughly cleaned, put everything back together.

## 8.5 FUME PASSAGES CLEANING

Clean the fume passages every year.



**Fig. 102 - Remove the screws**



**Fig. 103 - Remove the inspection cap**

- Open the door.
- Remove the 4 screws (see **Fig. 102**) and remove the inspection cap (see **Fig. 103**).



**Fig. 104 - Clean with pipe cleaner**



**Fig. 105 - Vacuum out the ash**

- Clean with a pipe cleaner and suction any ash accumulated inside (see **Fig. 104** and **Fig. 105**).
- After cleaning, repeat the operation in reverse making sure the gasket is intact and efficient: if necessary, provide for the replacement with original spare parts.



**Fig. 106 - Clean with pipe cleaner**



**Fig. 107 - .**



**Fig. 108 - Vacuum out the ash**

- Clean with a pipe cleaner and suction any ash accumulated inside (see **Fig. 106** and **Fig. 107 Fig. 108**).

## 8.6 FUME CHAMBER CLEANING

Every 4/8 weeks the fume chamber must be cleaned.

- Open the door and remove the ash drawer.
- There are 2 bases to be removed at the bottom of the combustion chamber. Loosen the bolts and remove the bases (see **Fig. 109**).
- Remove the screws locking the cast iron side walls (see **Fig. 110**).
- Remove the side cast iron (see **Fig. 111**).



**Fig. 109 - Removing the bases**



**Fig. 110 - Extracting soot**



**Fig. 111 - Side cast iron removal**

- Remove the central cast iron wall (see **Fig. 112**).
- Clean the fume passages with a pipe cleaner (see **Fig. 113**),
- Remove the soot inside it with a vacuum cleaner (see **Fig. 114**).
- Reassemble everything in the inverse order.



*Fig. 112 - Central cast iron removal*



*Fig. 113 - Cleaning with pipe cleaner*



*Fig. 114 - Remove soot*

## 8.7 SMOKE DUCT CLEANING

Monthly clean the exhaust system.



*Fig. 115 - Smoke duct cleaning*

- Remove the insert.
- Vacuum the flue gas exhaust as shown in **Fig. 115**.

## 8.8 GLASS REPLACEMENT

In case of break it is essential to replace it before using the stove.  
For glass replacement please proceed as follows:



Fig. 116 - Screw removal



Fig. 117 - Door profiles removal

- Remove the screws from glassweight profiles (see **Fig. 116**).
- Remove upper and lower profiles (see **Fig. 117**).
- Take out the damaged glass and replace it only with an original spare part. Please check that the gasket is not damaged and if necessary, have it replaced.
- Reassemble the profiles and screws.

## 9 IN CASE OF ANOMALY






### 9.1 PROBLEM SOLVING































*Before of every Authorized Technician intervention, the same Technician has the duty to check if the parameters of the mother board correspond to those of the table you own.*



*In case of doubts regarding the use of the stove, please contact ALWAYS the Authorized Technician on order to avoid irreparable damages!*

PROBLEM	CAUSE	SOLUTION	INTERVENTION
The control display does not switch on	The stove is without power supply	Check if the plug is connected.	
	Burned protection fuse in the electric socket	Replace the protection fuses in the electric socket (3.15A-250V).	
	Faulty control display	Replace the control display.	
	Faulty flat cable	Replace the flat cable.	
	Faulty electronic board	Replace the mother board.	

PROBLEM	CAUSE	SOLUTION	INTERVENTION
Pellets do not reach the combustion chamber	Empty hopper	Full the hopper.	
	Open fire door or open pellet door	Close fire door and pellet door and check that there are no pellet grains at the gasket level.	
	Clogged stove	Fume chamber cleaning	
	Auger blocked by a foreign object (for example nails)	Clean the auger.	
	The auger geared motor is out of order	Replace the geared motor.	
	Check if on the display there is an "ACTIVE ALARM"	Have the stove checked.	
The fire extinguish and the stove stops	Empty hopper	Full the hopper.	
	Auger blocked by a foreign object (for example nails)	Clean the auger.	
	Bad quality pellets	Try other types of pellets.	
	Pellet drop value too low "phase 1"	Adjust the pellet loading.	
	Check if on the display there is an "ACTIVE ALARM"	Have the stove checked.	
	The door does not close perfectly or the gaskets are worn	Check the door seal and replace the gaskets.	
	Ignition step is not completed	Empty the brazier and repeat ignition.	
	Clogged exhaust	The exhaust chimney is partially or totally obstructed. Call a skilled chimney technician to check from the stove exhaust to the chimneypot. Clean immediately.	

PROBLEM	CAUSE	SOLUTION	INTERVENTION
Flames are weak and orange coloured, pellets do not burn properly and the glass blackens	Not sufficient combustion air	Check as following: probable obstructions of the combustible air inlet from the back or from the bottom of the stove; burning pot obstructed holes with too ash remains. Have the fan blades and auger cleaned. (see SMOKE RPM VARIATION User Manual)	
	Obstructed exhaust	The exhaust chimney is partially or totally obstructed. Contact an expert stove-repairer who checks the stove from the exhaust up to the chimney pot. Provide immediately for stove cleaning.	
	Obstructed stove	Provide immediately at the inner cleaning of the stove.	
	The fume fan is out of order	The pellets can burn also thanks to chimney flue depression without the aid of the fume fan. Have the fume fan immediately replaced. It can be noxious to health to let the stove running without fume fan.	
The exchanger fan continues to turn even though the stove has just cooled	Faulty fume temperature probe	Replace the fume probe.	
	Faulty mother board	Replace the mother board.	
Ash remains along the stove	Faulty or out of order door gaskets	Replace the gaskets.	
	Not sealed fume pipes	Contact an expert stove-repairer who will immediately provide for sealing the junctions with high-temperature silicone and/or for replacing pipes with those in compliance to current regulations. A not sealed fume channelisation can be noxious to health.	
The stove is at its highest power but does not heat up.	Ambient temperature reached.	The stove is at its minimum value. Increase the desired ambient temperature.	
Stove running and display showing "Smoke Overtemperature"	Reached fume outlet limit temperature	The stove runs at minimum. NO PROBLEM!	
The stove's smoke duct produces condensation	Low smoke temperature	Check that the flue is not clogged.	
		Increase stove power to minimum (pellet drop and fan revs).	
		Install condensation collection cup.	
Stove running and display showing "SERVICE"	Routine maintenance alert (it does not block the system)	When this flashing message appears upon start-up, it means that the preset operating hours have elapsed before maintenance. Contact the service centre.	

## 10 TECHNICAL DATAS

### 10.1 FUSE REPLACEMENT

- For fuse replacement in the electric socket which stands on the back of the stove, extract the fuses to change with the aid of a screwdriver for opening the shutter (see **Fig. 118**).



Fig. 118 - Shutter with fuses to remove

## 11 FEATURES

DESCRIPTION	ZEFIRO3 9KW - ZEN AIRTIGHT	PONENTE 7 T1 - ZENITH 7 T1
WIDTH	69,7 cm	59 cm
DEPTH	55 cm	55 cm
HEIGHT	49 cm	49 cm
WEIGHT	94 kg	73 kg
INTRODUCED THERMAL POWER (Min/Max)	2,83 - 10,5 kW	3,7 - 7,8 kW
NOMINAL THERMAL POWER (Min/Max)	2,7 - 9,3 kW	3,3 - 6,8 kW
EFFICIENCY (Min/Max)	94,2 - 88,5 %	89,5 - 88 %
FLUE GAS TEMPERATURE (Min/Max)	79 - 197°C	115 - 174°C
MAXIMUM FLUE GAS FLOW RATE (Min/Max)	2,6 - 5,7 g/s	4,2 - 5,9 g/s
CO EMISSIONS (13% O <sub>2</sub> ) (Min/Max)	0,024 - 0,012 %	0,013 - 0,012 %
OGC EMISSIONS (13% O <sub>2</sub> ) (Min/Max)	3,3 - 2,6 mg/Nm <sup>3</sup>	2 - 1 mg/Nm <sup>3</sup>
NOX EMISSIONS (13% O <sub>2</sub> ) (Min/Max)	108 - 127 mg/Nm <sup>3</sup>	120 - 100 mg/Nm <sup>3</sup>
Average CO CONTENT at 13% O <sub>2</sub> (Min/Max)	294 - 148 mg/Nm <sup>3</sup>	162 - 150 mg/Nm <sup>3</sup>
Average DUST CONTENT at 13% O <sub>2</sub> (Min/Max)	19,2 - 19 mg/Nm <sup>3</sup>	15 - 15 mg/Nm <sup>3</sup>
FLUE NEGATIVE PRESSURE (Max)	11,9 Pa	11 Pa
ON SHARED FLUE	NO	NO
FLUE GAS EXHAUST DIAMETER	Ø80 mm	Ø80 mm
FUEL	Pellet Ø6-7 mm	Pellet Ø6-7 mm
PELLET HEATING CAPACITY	5 kWh/kg	5 kWh/kg
PELLET HUMIDITY	≤ 10%	≤ 10%
HEATABLE VOLUME 18/20°C Coeff. 0.045 kW (Min/Max)	77 - 265 m <sup>3</sup>	92 - 190 m <sup>3</sup>
HOURLY CONSUMPTION (Min/Max)	0,59 - 2,17 kg/h	0,7 - 1,6 kg/h
HOPPER CAPACITY	15 kg	8 kg
RANGE (Min/Max)	25 - 7 h	14 - 16 h
POWER SUPPLY	230 V - 50 Hz	230 V - 50 Hz
ABSORBED POWER (Max)	346 W	370 W
STARTER RESISTANCE ABSORBED POWER	300 W	300 W
MINIMUM EXTERNAL AIR VENT (final cross-section)	80 cm <sup>2</sup>	80 cm <sup>2</sup>
SEALED CHAMBER STOVE	SI	SI
EXTERNAL AIR VENT FOR SEALED CHAMBER	60 mm	60 mm
DISTANCE FROM COMBUSTIBLE MATERIAL (back/side/bottom)	50 / 200 / 0 mm	50 / 200 / 0 mm
DISTANCE FROM COMBUSTIBLE MATERIAL (ceiling/front)	750 / 1000 mm	750 / 1000 mm





89022119B

Rev. 00-2024

**CADEL srl**  
**31025 S. Lucia di Piave - TV**  
**Via Martiri della Libertà, 74 - Italy**

**[www.cadelsrl.com](http://www.cadelsrl.com)**  
**[www.free-point.it](http://www.free-point.it)**