

INSTALLER MANUAL

PELLET THERMOSTOVE







Original Instructions | ©2022 CADEL srl | All rights reserved - Tutti i diritti riservati

RIVER IDROTECH 18 - RIVER IDROTECH 24
RIVER IDROTECH 24H₂O

SUMMARY

1	MANUAL SIMBOLOGY	2
2	PACKAGING AND HANDLING	2
2.1	PACKAGING	2
2.2	PREPARATION AND UNPACKING	2
2.3	STOVE HANDLING.....	4
3	CHIMNEY FLUE	4
3.1	PREPARING THE SMOKE EXPULSION SYSTEM.....	4
3.2	CHIMNEY COMPONENTS	4
3.3	SMOKE DUCT (SMOKE FITTING).....	5
3.4	FLUE (CHIMNEY OR PIPED DUCT)	5
3.5	CHIMNEY POT.....	6
3.6	MAINTENANCE.....	7
4	COMBUSTION AIR	7
4.1	AIR INLET	7
4.2	COMBUSTIBLE AIR INLET FOR SEALED-CHAMBER INSTALLATION	8
5	EXAMPLES OF INSTALLATION (DIAMETERS AND LENGTHS TO BE SIZED)	9
6	INSTALLATION	10
6.1	INTRODUCTION	10
6.2	MINIMUM DISTANCES.....	11
6.3	OVERALL DIMENSIONS	12
6.4	STOVE DOOR REMOVAL/INSTALLATION	12
6.5	FITTING THE METAL FRAME OF RIVER- IDROTECH 18 - 24 - 24 H ₂ O.....	13
6.6	ASSEMBLING THE TOP CLADDING AND BOTTOM DOOR	13
6.7	FITTING THE MAIOLICA FRAME OF RIVER- IDROTECH 18 - 24 - 24 H ₂ O.....	14
6.8	ELECTRIC CONNECTION	14
6.9	STOVE CALIBRATION AND DEPRESSION MEASUREMENT	15
7	PLUMBING CONNECTION	16
7.1	PLUMBING SYSTEM CONNECTION.....	16
7.2	CONNECTION DIAGRAM RIVER - IDROTECH 18 - 24 (SENZA DHW)	16
7.3	CONNECTION DIAGRAM RIVER - IDROTECH 24 H ₂ O DHW	17
7.4	3 BAR DISCHARGE VALVE	17
7.5	WASHING THE SYSTEM	18
7.6	FILLING THE SYSTEM.....	18
7.7	WATER CHARACTERISTICS	19
7.8	SYSTEM CONFIGURATION	19
7.9	CONFIGURATION 1.....	19
7.9.1	SYSTEM WITH: DIRECT PELLET STOVE AND ROOM PROBE OR EXTERNAL THERMOSTAT** (OPTIONAL).....	19
7.10	CONFIGURATION 2.....	21
7.11	CONFIGURATION 3.....	23
7.12	CONFIGURATION 4.....	25
7.13	CONFIGURATION 5.....	26
7.14	CONFIGURATION WITH STORAGE TANK AND AUXILIARY WALL-MOUNTED BOILER (EXAMPLE)	27
7.15	OPERATING MODE.....	28
7.16	ELECTRICAL CONNECTIONS.....	29
8	SPECIAL MAINTENANCE	30
8.1	INTRODUCTION	30
8.2	DIRTY GLASS	30
8.3	FUME CONDUIT CLEANING.....	31
8.4	SMOKE EXTRACTOR COMPARTMENT CLEANING...31	
8.5	CLEANING THE SMOKE EXTRACTION SYSTEM AND GENERAL CHECKS	31
8.6	DOOR CLOSING FUNCTIONALITY PERIODIC CHECK32	
8.7	FUME PASSAGES CLEANING.....	32
8.8	CLEANER BLOCKED.....	33
8.9	REPLACING THE OVERPRESSURE RELIEF VALVE FOR THE COMBUSTION CHAMBER	33
8.10	FUME PIPES ANNUAL CLEANING	34
8.11	GASKET REPLACEMENT.....	34
9	IN CASE OF ANOMALY	34
9.1	PROBLEM SOLVING	34
9.2	PROBLEM SOLVING (THERMOSTOVE)	38
10	TECHNICAL DATAS	40
10.1	ELECTRONIC BOARD WITHOUT DHW	40
10.2	ELECTRONIC BOARD WITH DHW	41
10.3	REPAIR INFORMATION	44
11	FEATURES	45

1 MANUAL SIMBOLOGY

	USER
	AUTHORISED TECHNICIAN (ONLY to interpret or the Stove-manufacturer or the Authorized Technician of Technical Assistance Service approved by the Stove-manufacturer)
	SPECIALIZED STOVE-REPAIRER
	CAUTION: READ CAREFULLY THE NOTE
	CAUTION: DANGER OR IRREVERSIBLE DAMAGE POSSIBILITY

- The icons with the stylized figures indicates whom the subject dealt in the paragraph is addressed to (between the User and/or the Authorized Technician and/or the Specialized Stove-repairer).
- WARNING symbols indicates an important note.

2 PACKAGING AND HANDLING

2.1 PACKAGING

- The packaging is made up of recyclable cardboard boxes according to RESY standards, recyclable expanded polystyrene inserts and wooden pallets.
- All packaging materials can be re-used for a similar use or eventually discharged as waste assimilable to the municipal solid ones, in accordance with current regulations.
- After having removed the packaging please assure you about the integrity of the product.

2.2 PREPARATION AND UNPACKING

The product is packaged in a recyclable cardboard box according to RESY standards, on a wood pallet. All the packaging materials can be reused for similar purposes or, in the event, disposed of as waste assimilable to urban solid waste, following the standards in force. After having removed the packaging, make sure the product is intact.



Handle the product with appropriate means, respecting the safety standards in force. Do not overturn the packaging and use caution for the ceramic details.

The stoves are delivered in a single package with ceramic panels or steel sides packaged along with the structure and positioned either on top or to the side. Open the packaging, remove the cardboard and any supporting polystyrene and place the stove in the selected location, making sure it complies with the requirements.

The stove body or single unit must always be handled upright exclusively using hand trucks. Be especially careful to protect the door and its glass from mechanical impacts that would compromise their integrity.

If possible, unpack the stove near the area in which it will be installed.

The packaging materials are neither toxic nor harmful.

To take the stove off the pallet, remove the two "U" screws and slide the "S" plate out from the stove foot. There are four "S" brackets (see below).

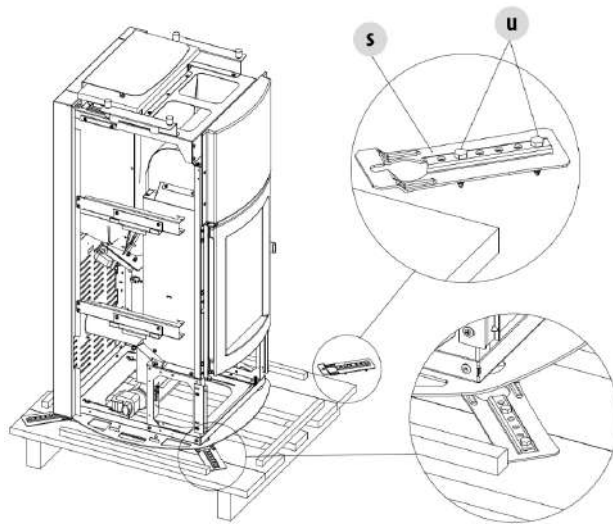

Fig. 1 - Remove the fastening brackets

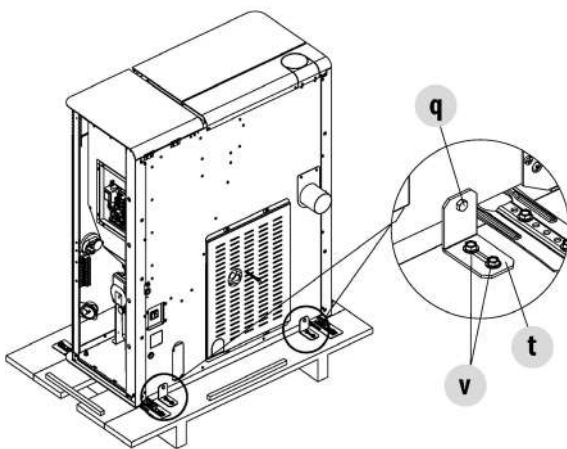

Fig. 2 - Remove the fastening brackets

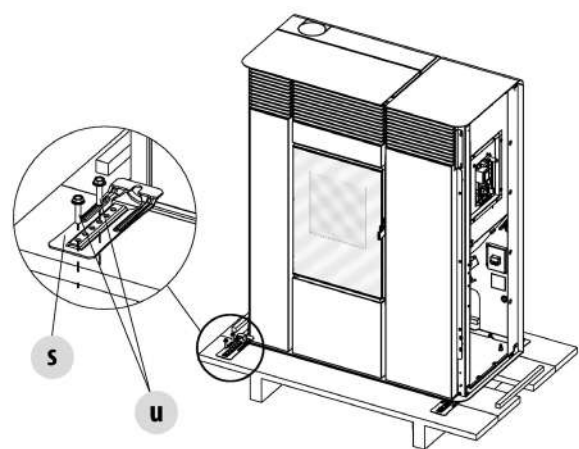

Fig. 3 - Remove the fastening brackets

Position the stove and connect it to the smoke duct. Adjust the 4 feet (J) to find the right level so that the smoke duct and pipe are coaxial. If the stove needs to be connected to an exhaust pipe that goes through the back wall (to go into the flue), be extremely careful not to force it.



Forcing the stove smoke exhaust or using it improperly to lift or position the stove will irreversibly compromise its function.

Turning the feet clockwise lowers the stove. Turning the feet anticlockwise raises the stove (see below).



Fig. 4 - Foot adjustment

2.3 STOVE HANDLING

Both whether the stove is packed or not it is necessary to observe the following instructions for handling and transporting the stove from its sale point to its installation point and for any future movements:

- The stove must be handled with idoneous means paying attention to the existing safety regulations;
- do not turn the stove upside down and/or upset it on one side, but keep it in vertical position or as accorded with the constructor instructions;
- if the stove is made up of ceramic, stone, glass or any particularly fragile material components, all must be moved with the utmost care.

3 CHIMNEY FLUE

3.1 PREPARING THE SMOKE EXPULSION SYSTEM

The combustion product expulsion system is a particularly important element for the proper operation of the appliance and must be correctly sized according to EN 13384-1.

Its creation/adaptation/verification must always be carried out by a legally qualified operator and must comply with the regulations in force in the country where the appliance is installed.

The Manufacturer declines all liability for malfunctions caused by a badly sized and non-compliant smoke expulsion system.

3.2 CHIMNEY COMPONENTS

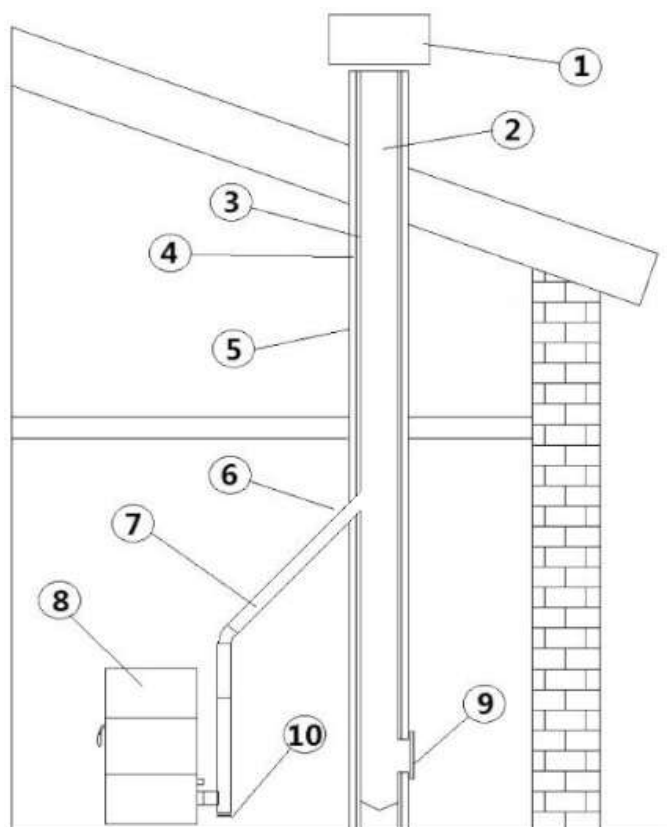

Fig. 5 - Chimney components

LEGEND	Fig. 5
1	Chimney pot
2	Fume outlet
3	Chimney flue
4	Thermal insulation
5	External wall
6	Chimney union
7	Fume pipe
8	Heat generator
9	Inspection door
10	T-union with inspection plug

3.3 SMOKE DUCT (SMOKE FITTING)

The smoke duct is the pipe that connects the appliance to the flue.

This smoke fitting must comply in particular with the following requirements:

- comply with product standard EN 1856-2;
- its cross-section must be of constant diameter and no less than that of the appliance outlet, from the firebox outlet up to the connection in the flue;
- the horizontal section must be as short as possible and extend no more than 4 metres;
- the horizontal sections must have a minimum upward slope of 3%;
- changes of direction must have an angle no greater than 90° and be easy to inspect
- the number of changes of direction, including that for entry into the flue, and exclusion of the T in the event of a side or rear outlet, must not exceed 3;
- it must be insulated if it passes outside the installation room
- it must not in any case cross rooms in which it is forbidden to install combustion appliances.
- the use of flexible metal and fibre cement or aluminium hoses is forbidden;

In any case, smoke ducts must be sealed against combustion products and any condensation. For this reason, it is recommended to use pipes with silicone gaskets or similar sealing devices that withstand the operating temperatures of the appliance (e.g. T200 P1) and that by removing the gaskets, are still T400 N1 G certified.

SYSTEM TYPE	Ø80 mm PIPE	Ø100 mm PIPE
Minimum vertical length	1,5 mt	2 mt
Maximum length (with 1 union)	6,5 mt	10 mt
Maximum length (with 3 unions)	4,5 mt	8 mt
Maximum number of unions	3	3
Level section (minimum inclination 3%)	4 mt	4 mt
Installation at a height above 1200 m a.s.l.	NO	Obligatory

3.4 FLUE (CHIMNEY OR PIPED DUCT)

When creating the flue, in particular comply with the following requirements:

- comply with the applicable product standard (EN 1856, EN 1857, EN 1457, EN 1806, EN 13063..);
- be made with suitable materials to ensure resistance to normal mechanical, chemical, thermal stresses and have adequate thermal insulation in order to limit the formation of condensate;
- have a predominantly vertical configuration and be free of choke points along its entire length;
- be correctly spaced by air gaps and isolated from combustible materials;
- the flue inside the house must still be insulated and can be inserted in an air shaft provided it complies with the regulations for piping;
- the smoke duct must be connected to the flue by means of a Tee fitting with an inspectable collection chamber for the collection of soot and any condensate.
- where the sizing provides for wet operation, a suitable condensate collection and siphon discharge system must be set up.



We recommend checking the data plates of the flue for the safety distances that must be observed in the presence of combustible materials and, if necessary, the type of insulating material to be used. It is forbidden to connect the stove to a collective or shared flue with other combustion appliances or with hood outlets. It is forbidden to use the direct drain on the wall or towards indoor spaces and any other form of drain not provided for by the regulation in force in the country of installation.

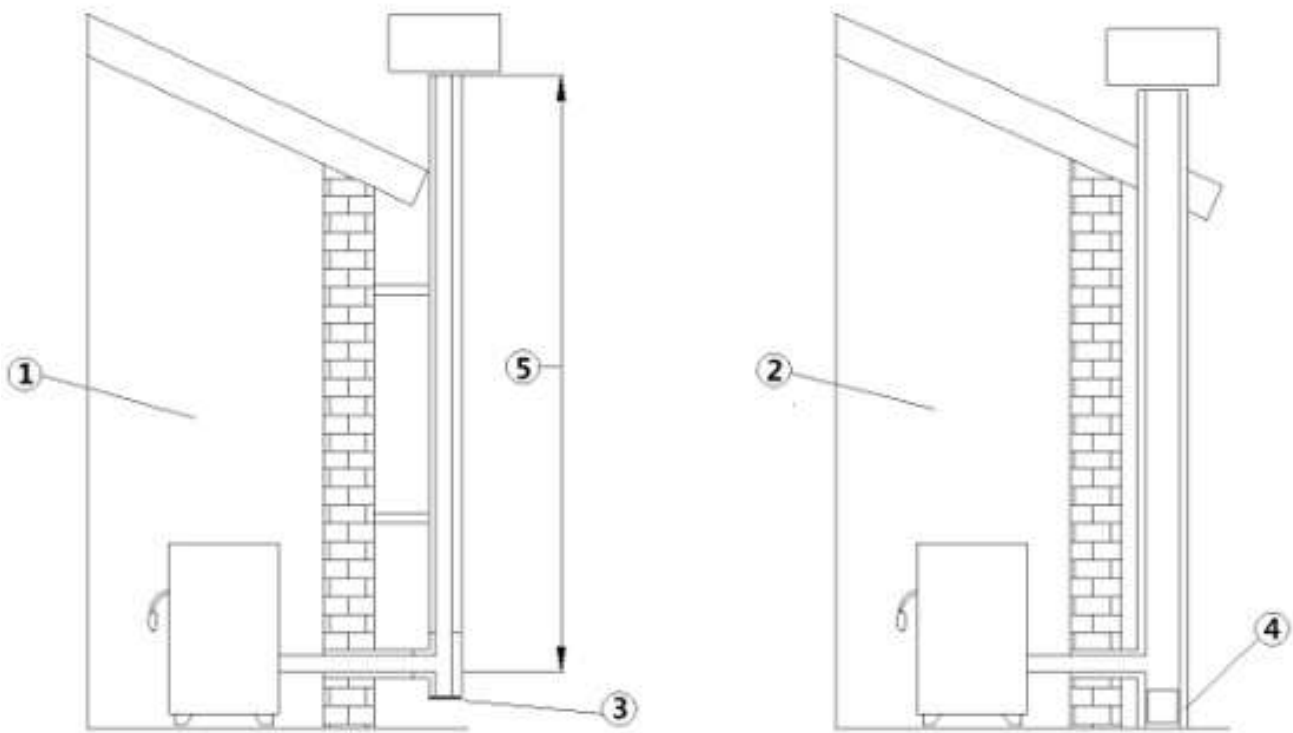

Fig. 6 - Chimney Flues

LEGEND	Fig. 6
1	Chimney flue with insulated stainless-steel pipes
2	Chimney flue on the existing chimney
3	Inspection plug
4	Inspection door

- The chimney flue must be provided CE in accordance with EN 1443 regulation. Please find attached an example of label:

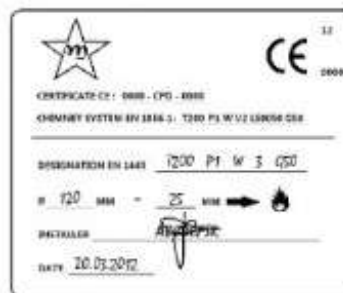

Fig. 7 - Example of label

3.5 CHIMNEY POT

The chimney pot, meaning the end part of the flue, must meet the following characteristics:

- the smoke outlet section must be at least double the internal section of the chimney;
- prevent the penetration of rain or snow;
- ensure the outlet of smoke even in the event of wind (windproof chimney pot);
- the height of outflow must be beyond the reflux area (**) (refer to national regulations to identify the reflux area);
- always be built at a distance from antennas or dishes, and never be used as a support.

(**) unless there are specific national derogations (clearly specified in the corresponding instruction manual in English) which under appropriate conditions allow it; in this case, strictly follow the product/installation requirements of the relative regulations/technical specifications/legislation in force in that country.

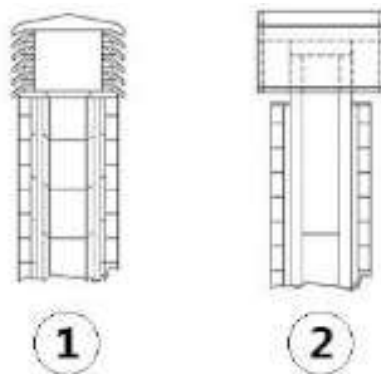

Fig. 8 - Anti-wind chimney pots

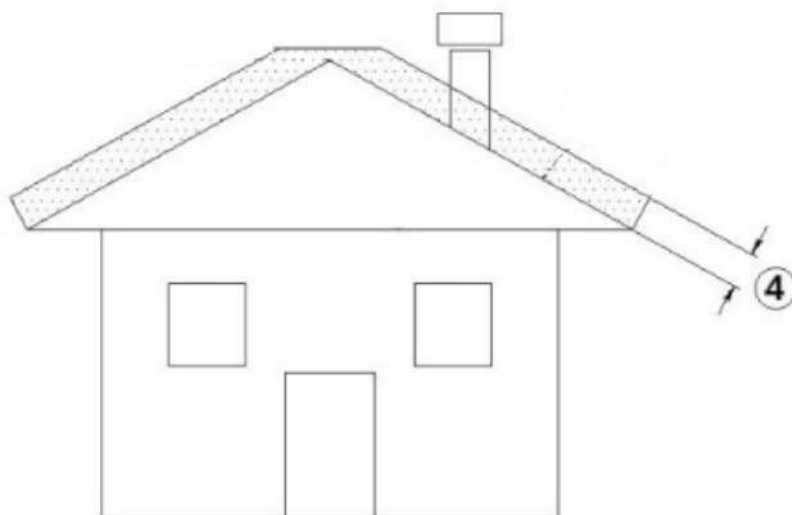

Fig. 9 - Reflux area

3.6 MAINTENANCE

- The fumes extraction pipes (fumes conduit + chimney flue + chimney pot) must always be cleaned, scrubbed and checked by an expert stove-repairer, in compliance with current regulations, with the instructions of the stove-manufacturer and the directives of your insurance company.
- In case of doubts, please follow the most restrictive regulations.
- Have your chimney flue and chimney pot checked and cleaned by an expert chimney sweep at least once a week. The chimney sweep has to release a written declaration about the security of the system.
- Not cleaning compromise safety.

4 COMBUSTION AIR

4.1 AIR INLET

It is mandatory to provide an adequate external air inlet that supplies the combustion air required for the product to work properly. The flow of air between the outside and the installation room can take place with a free air inlet or by channelling the air directly to the outside (***) .

The free air inlet must be:

- be made at floor level and in any case not higher than the height of the appliance;
- always be protected with an outer grille and in such a way that it cannot be obstructed by any object;
- have a minimum total free area of 80 cm² (net of the grille);

The presence of other suction devices (e.g.: vmc, electric fan for stale air extraction, kitchen hood, other stoves, etc.), in the same room, or in communicating rooms of the same housing unit, could cause negative pressure in the room. In this case, with the exception of sealed installations, one must verify that, with all the equipment on, no more than 4 Pa of negative pressure is created inside the installation room with respect to the outside. If necessary, increase the air inlet section.

It is possible to duct the air required for combustion to the outside by connecting the external air inlet directly with the combustion air inlet which is usually found on the back of the appliance.

The external ducted air vents must be:

- made close to the floor and anyway not higher than the appliance
- protected by a grille that guarantees a clear surface equal to the cross-section of the duct and made so that it cannot be obstructed by any object
- The air vent can be made directly on a wall of the installation room communicating with the outside, or indirectly in adjacent rooms that permanently communicate with the installation room, according to that set forth by standards in force.

The duct must comply with the following dimensions (each 90° bend is equivalent to one linear metre):

(***) In the event the combustion air is ducted on unsealed products, still verify that no more than 4 Pa of negative pressure is created inside the installation room with respect to the outside, otherwise provide for an additional air intake in the room.

Below 15 kW:

Air duct diameter	Maximum length (smooth duct)	Maximum length (corrugated duct)
50 mm	2 m	1 m
60 mm	3 m	2 m
80 mm	7 m	4 m
100 mm	12 m	9 m

Above 15 kW:

Air duct diameter	Maximum length (smooth duct)	Maximum length (corrugated duct)
50 mm	-	-
60 mm	1 m	-
80 mm	3 m	1 m
100 mm	7 m	4 m

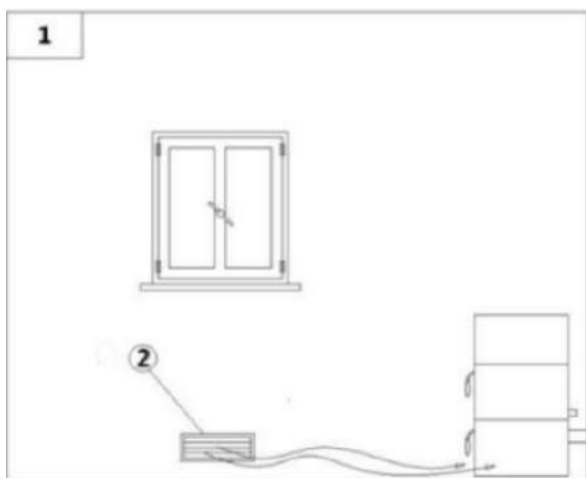

Fig. 10 - Direct air inflow

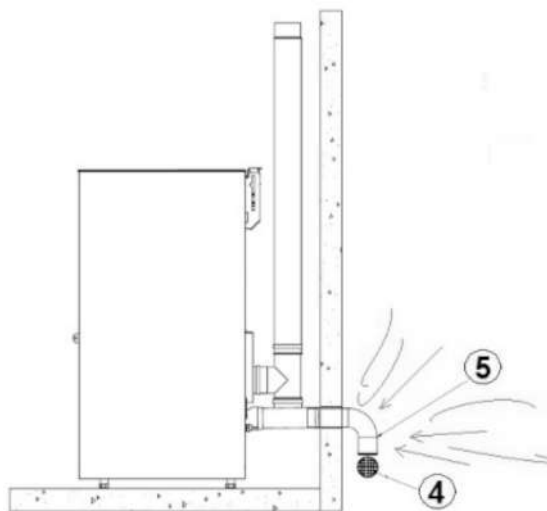

Fig. 11 - Air inlet for sealed-chamber installation

LEGEND	Fig. 10 Fig. 11
1	Room to ventilate
2	External air inlet
4	Shield grid
5	Curve inlet to turn downwards

4.2 COMBUSTIBLE AIR INLET FOR SEALED-CHAMBER INSTALLATION

How to connect to the stove in the sealed chamber with concentric system:



Fig. 12 - Phase1

- Connect the air intake pipe to the combustion air pipe of the stove and tighten everything with a clamp (see [Fig. 12]).

5 EXAMPLES OF INSTALLATION (DIAMETERS AND LENGTHS TO BE SIZED)

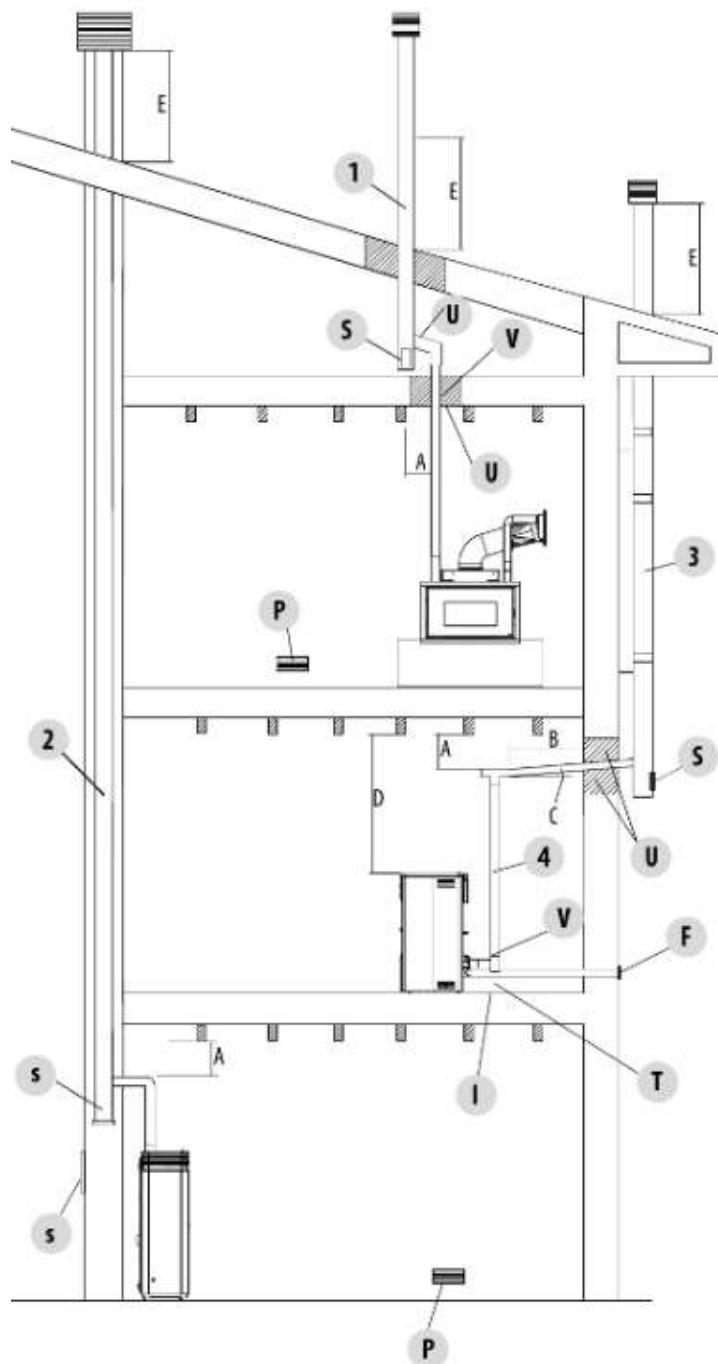

Fig. 13 - Chimney flue

1. Flue installation with hole for the passage of the pipe increased by:
 minimum 100mm around the pipe if next to non-flammable parts such as cement, brick, etc.; or minimum 300mm around the pipe (or as required by plate data) if next to flammable parts such as wood etc.
 In both cases, install suitable insulation between the flue and the ceiling.
 Always check and comply with the plate data of the flue, specifically the minimum safety distances from combustible materials.
 The previous rules also apply for holes made in walls.
2. Old flue, pipe with the inclusion of an external access door for chimney cleaning.
3. External flue made of insulated stainless-steel pipes, i.e. with double walls: all securely mounted on the wall. With windproof chimneypot.
4. Ducting system using Tee fittings that allow easy access for cleaning without having to remove the pipes.

LEGEND	Fig. 13
U	Insulation
V	Possible diameter increase
I	Inspection cap
S	Inspection access panel
P	Air inlet
T	Tee fitting with inspection cap
A	Distance from flammable material (smoke duct plate)
B	Maximum 4 m
C	Minimum 3° slope
D	Distance from flammable material (appliance plate)
E	Reflux area
F	Air ducting



The instructions in this chapter refer explicitly to the Italian installation regulation UNI 10683. In any case, always observe the regulations in force in the country of installation.

6 INSTALLATION

6.1 INTRODUCTION

The heating system (generator + combustion air supply + combustion product expulsion system + any hydraulic/aerualic system) must be installed in compliance with the laws and regulations in force (*), and carried out by a qualified technician, who must issue a declaration of conformity of the system to the system manager and shall undertake full responsibility for final installation and consequent good operation of the product.

The manufacturer declines all responsibility in the event of installations that do not comply with the laws and regulations in force and inappropriate use of the appliance.

In particular one must ensure that:

- the environment is suitable for installing the appliance (floor load-bearing capacity, presence or possibility of creating an adequate electrical/hydraulic/aerualic system when required, volume compatible with the appliance characteristics, etc.);
- the appliance is connected to a smoke expulsion system correctly sized according to EN 13384-1, which is resistant to soot fire and which complies with the distances prescribed by the combustible materials indicated on the plate data;
- there is a suitable combustion air flow to the appliance;
- other combustion appliances or extraction devices installed do not cause a negative pressure of more than 4 Pa in the room where the product is installed compared to the outside (only sealed appliances are allowed a maximum of 15 Pa of negative pressure in the room).

(*): *The national reference standard for the installation of domestic appliances is UNI 10683 (IT) - DTU NF 24.1 (FR) - DIN 18896 (DE) - NBN B 61-002 (BE) - Real Decreto 1027/2007 (ES) - Paesi Bassi (NL) Bouwbesluit - Danmark (DK) BEK n° 541 del 27/04/2020.*

In particular, it is recommended to strictly observe the safety distances from combustible materials to avoid serious harm to people and to the integrity of the home.

Installation of the appliance must ensure easy access to service the appliance itself, the smoke channels and the flue. Always maintain adequate distance and protection in order to prevent the product from coming into contact with water.

It is forbidden to install the stove in rooms with a fire hazard.

With the exception of sealed installations, it is also forbidden for liquid fuel appliances with continuous or intermittent operation that draw the combustion air from the room they are installed in or B-type gas heating appliances, with or without the production of domestic hot water, to coexist in the same room or in interconnecting rooms.



Sealed installation means that the product is certified as sealed and its installation (ducting of the combustion air and connection to the chimney) is airtight with respect to the installation environment.

A sealed installation does not consume the room's oxygen because it draws all the air from the outer environment (if suitably ducted) and makes it possible to install the product in all houses that require a high degree of insulation such as "passive" or "high energy efficiency" houses. Thanks to this technology there is no risk of smoke emissions in the room and no air inlets - hence not even the relevant ventilation grilles - are required in the installation premises.

Consequently, there will be more draughts of cold air in the room, thus making it more comfortable and increasing the overall efficiency of the system. The sealed stove in a sealed installation is compatible with the presence of forced ventilation or premises that might have negative pressure with respect to the outside.

6.2 MINIMUM DISTANCES

Observe the distances from flammable objects (sofas, furniture, wood panelling, etc.) as specified in the following diagram. If objects considered to be particularly sensitive to heat are present, such as furniture, curtains or sofas, as a precaution, increase the stove clearances substantially to avoid possible deterioration due to the effect of heat.

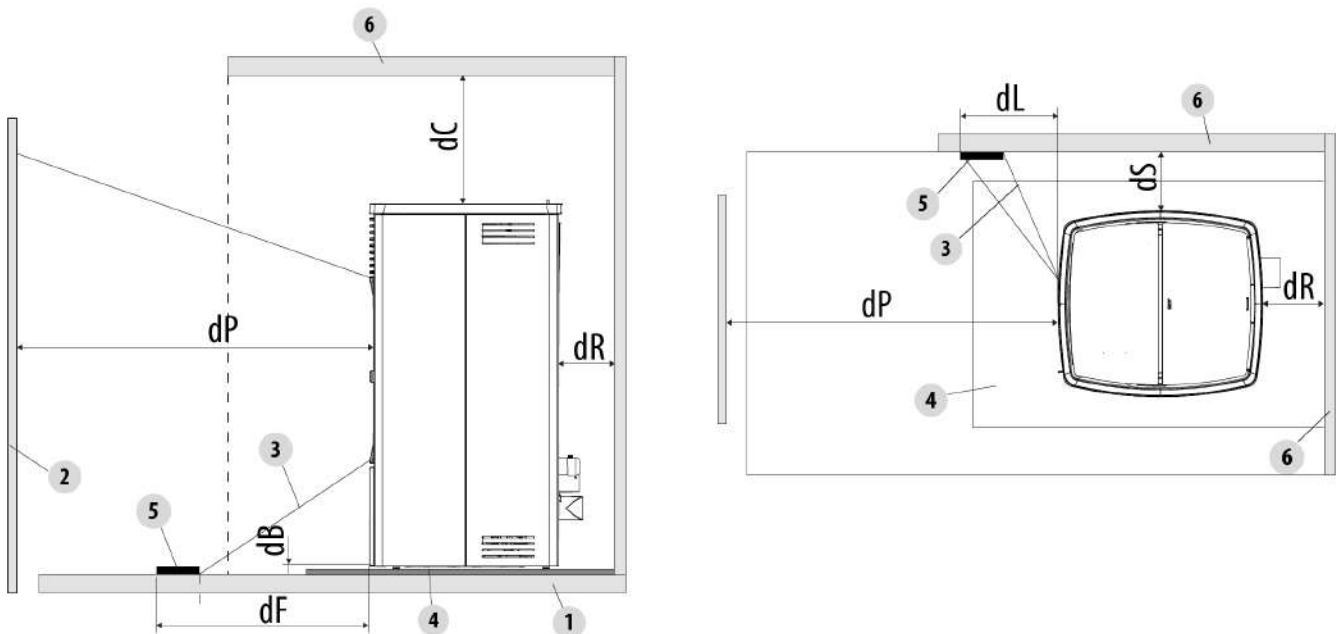

Fig. 14 - Safety distances from combustible material.

.LEGENDA	Fig. 14
<i>dR (rear distance)</i>	200 mm
<i>dS (side distance)</i>	300 mm
<i>dB (lower distance)</i>	0 mm
<i>dC (upper distance)</i>	750 mm
<i>dP (front radiation)</i>	1000 mm
<i>dF (floor radiation)</i>	1000 mm
<i>dL (side radiation)</i>	1000 mm
1	FLOOR
2	FRONT FLAMMABLE MATERIAL
3	AREA SUBJECT TO RADIATION

<i>.LEGENDA</i>	<i>Fig. 14</i>
4	FLOOR GUARD
5	RADIATED SURFACE TO BE PROTECTED
6	REAR/SIDE/UPPER FLAMMABLE SURFACE

If the floor is made of combustible material, use a protection made of non-combustible material (steel, glass...) that also protects the front from any falling combusted material during cleaning operations.



Always fit a floor guard if the floor is made of flammable material.

Install the stove also detached from any non-combustible walls/surfaces, observing a minimum clearance of **200mm** (back) and **300mm** (side) to allow effective aeration of the appliance and a good distribution of heat in the room.

In any case, ensure adequate distance to facilitate access during cleaning and extraordinary maintenance. If this is not possible, it must still be possible to distance the product from adjacent walls/elements.

This operation (**1***) must be performed by a technician qualified to disconnect the combustion product expulsion ducts and their subsequent restoration.

For generators connected to the hydraulic system, a connection must be provided between the system itself and the product so that, during extraordinary maintenance, carried out by a qualified technician, it is possible to move the generator 1 by at least 50 cm from adjacent walls without emptying the system (e.g. by using a double shut-off gate or suitable flexible connection).

(**1***) The national reference standard for the installation of domestic appliances is UNI 10683 (IT) - DTU NF 24.1 (FR) - DIN 18896 (DE) - NBN B 61-002 (BE) - Real Decreto 1027/2007 (ES) Paesi Bassi (NL) Bouwbesluit - Danmark (DK) BEK n° 541 del 27/04/2020.

6.3 OVERALL DIMENSIONS

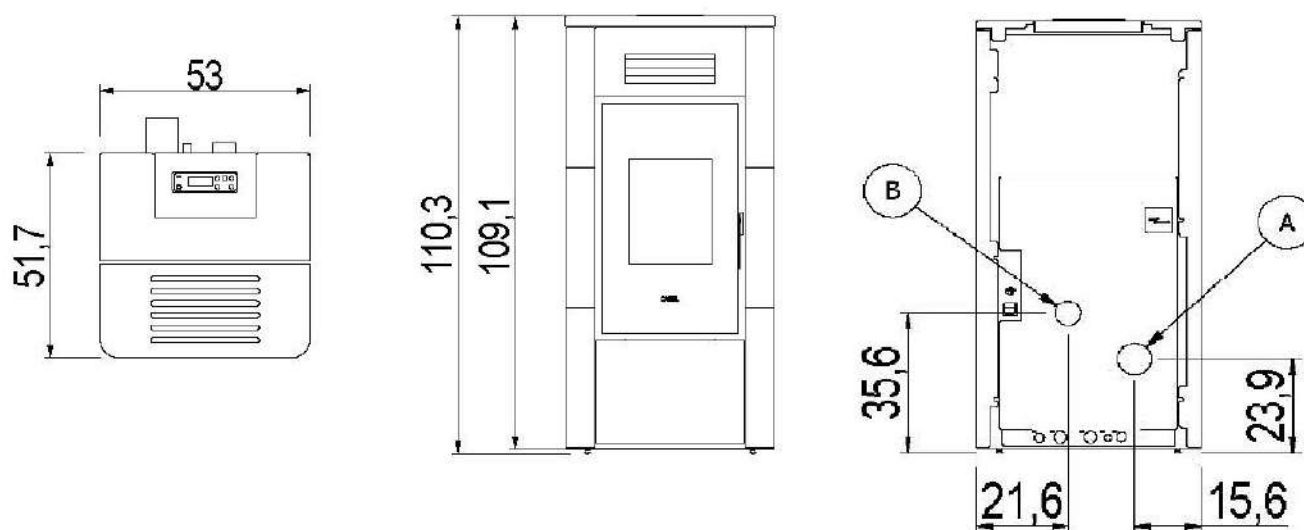

Fig. 15 - RIVER IDROTECH 18 - 24 - 24 H20

<i>LEGEND</i>	<i>Fig. 15</i>
A	Exhaust fumes d.8 cm
B	Hole combustion air inlet d.5 cm

6.4 STOVE DOOR REMOVAL/INSTALLATION

For some operations (e.g.: side panel assembly and cleaning) you must remove the stove door.

To remove the door:

- Open the door.
- Undo the screws from the upper hinge (see **Fig. 16**).
- Remove the hinge, keeping the door in position (see **Fig. 17**).
- Lift the door and release it from the lower hinge.
- To assemble, proceed in reverse order.



Fig. 16 - Removing the screws



Fig. 17 - Remove the hinge

6.5 FITTING THE METAL FRAME OF RIVER- IDROTECH 18 - 24 - 24 H₂O

To assemble the frame, proceed as follows:

- Remove the top panel **Fig. 18**.



Fig. 18 - Remove the panel



Fig. 19 - Attach the frame to the stove in the slots



Fig. 20 - 1st slot



Fig. 21 - 2st slot

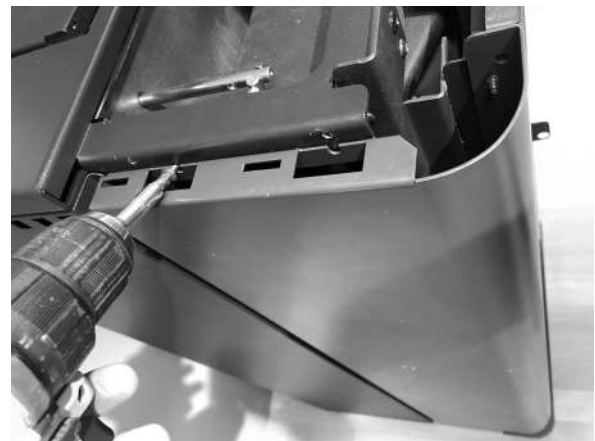

Fig. 22 - Secure the frame

6.6 ASSEMBLING THE TOP CLADDING AND BOTTOM DOOR

To assemble the cladding, proceed as follows:
Place the top panel on the stove (if maiolica).
Attach the top in the specific slots (if in metal).



Fig. 23 - Placing the top panel



Fig. 24 - Hook the panel



Fig. 25 - Hook the panel.

6.7 FITTING THE MAIOLICA FRAME OF RIVER- IDROTECH 18 - 24 - 24 H₂O

To assemble the frame, proceed as follows:



Fig. 26 - Fitting the maiolica panels



Fig. 27 - Bottom slot



Fig. 28 - Attach the panel



Fig. 29 - Securing the panel

6.8 ELECTRIC CONNECTION



Warning: the appliance must be installed by an authorized technician!

- The electric connection occurs through a cable with plug put in an electric socket which is able to support charge and tension specific of every model, as described in the technical datas table (see **FEATURES a pag. 44**).
- The plug must be easily accessible when the appliance is installed.
- Please further assure you that your network is endowed with an efficient earth connection: if it does not exist or if it is not efficient, please endow you with one in compliance with the law.
- Connect the supply cable first on the back of the stove (see **Fig. 30** and **Fig. 31**) and then at a wall electric socket.



Fig. 30 - Electric socket with master switch



Fig. 31 - Plug connected

- Do not use extension cables.
- If the feeder cable is damaged, it must be replaced by an authorized technician.
- When the stove is not going to be used for a long period of time, it is advisable to remove the plug from the socket on the wall.
- An electrical connection to a UPS/ACCUMULATOR/ STABILISER must guarantee a voltage of at least 210 V without power surges. Considering the variety of UPS on the market regarding size and construction qualities, we cannot guarantee operation once the stove is connected to these devices.

6.9 STOVE CALIBRATION AND DEPRESSION MEASUREMENT

This stove has a pickup point positioned on the tank in order to measure the depression of the combustion chamber and verify its proper operation.

To do this, proceed as follows:

- Connect a digital pressure switch with a tube to detect the negative pressure (see **Fig. 32 Fig. 33**).
- Load the feed screw via appropriate function.
- Start the stove and set "Set flame" to power 1 (the start-up time of this stove lasts between 8 and 10 minutes to ensure minimum draught).
- Compare the read values with those on the table.
- Change power every 10 minutes and wait for it to stabilise.
- Access the user menu and, if necessary, change the parameters.



Fig. 32 - Cap removal



Fig. 33 - Digital pressure switch connection

DATA	P1	P2	P3	P4	P5
Stove depression - temperature IDRO 18 kW	20 Pa - 125 °C	30 Pa - 150 °C	42 Pa - 178 °C	54 Pa - 200 °C	65 Pa - 230 °C
Stove depression - temperature IDRO 24 kW	20 Pa - 125 °C	35 Pa - 160 °C	45 Pa - 190 °C	60 Pa - 220 °C	75 Pa - 250 °C
Stove depression - temperature IDRO 24H20 kW	20 Pa - 125 °C	35 Pa - 160 °C	45 Pa - 190 °C	60 Pa - 220 °C	75 Pa - 250 °C

NB: for good combustion, the depression values must be between ± 5 Pa and the temperature values between $\pm 10^\circ\text{C}$.

7 PLUMBING CONNECTION

7.1 PLUMBING SYSTEM CONNECTION



IMPORTANT!

If installation of the product involves interaction with another, pre-existing system complete with heating equipment (gas boiler, methane boiler, diesel boiler, etc.), contact qualified personnel, who subsequently will be responsible for conformity of the system in compliance with the applicable law in force. The Company declines all responsibility for damage to persons or things in the event of failed or incorrect operation, if the aforementioned warnings are not complied with.



IMPORTANT!

WE STRONGLY RECOMMEND WASHING THE ENTIRE SYSTEM BEFORE CONNECTING THE STOVE IN ORDER TO REMOVE RESIDUE AND BUILD-UPS.

Always install gate valves upstream of the stove to isolate it from the hydraulic system should it be necessary to move it for routine and/or special maintenance. Connect the stove using flexible hoses so as not to excessively bind the stove to the system and to allow it to be moved slightly.

The pressure discharge valve must always be connected to a water discharge pipe. The pipe must be suitable to withstand the high water temperature and pressure.

7.2 CONNECTION DIAGRAM RIVER - IDROTECH 18 - 24 (SENZA DHW)

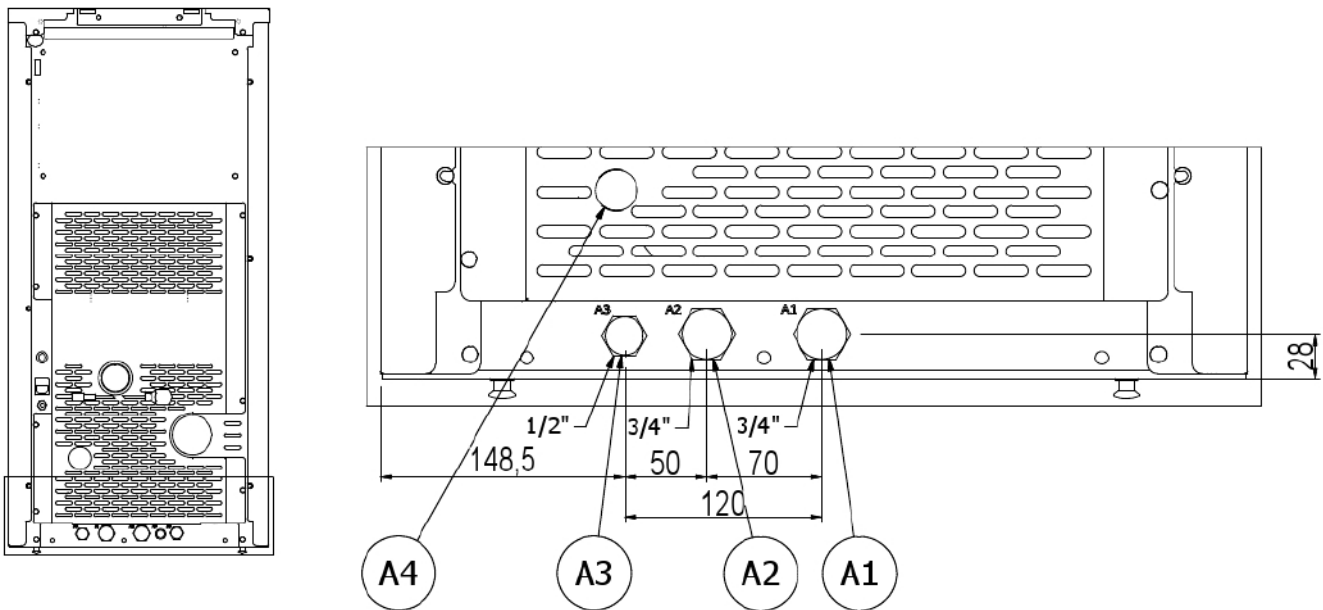

Fig. 34 - Connection diagram (senza DHW)

LEGEND	Fig. 34
A1	3/4" M heating water delivery
A2	3/4" M heating water return
A3	System filling
A4	System draining
B=150 - C=260	RIVER-IDROTECH

7.3 CONNECTION DIAGRAM RIVER - IDROTECH 24 H₂O DHW

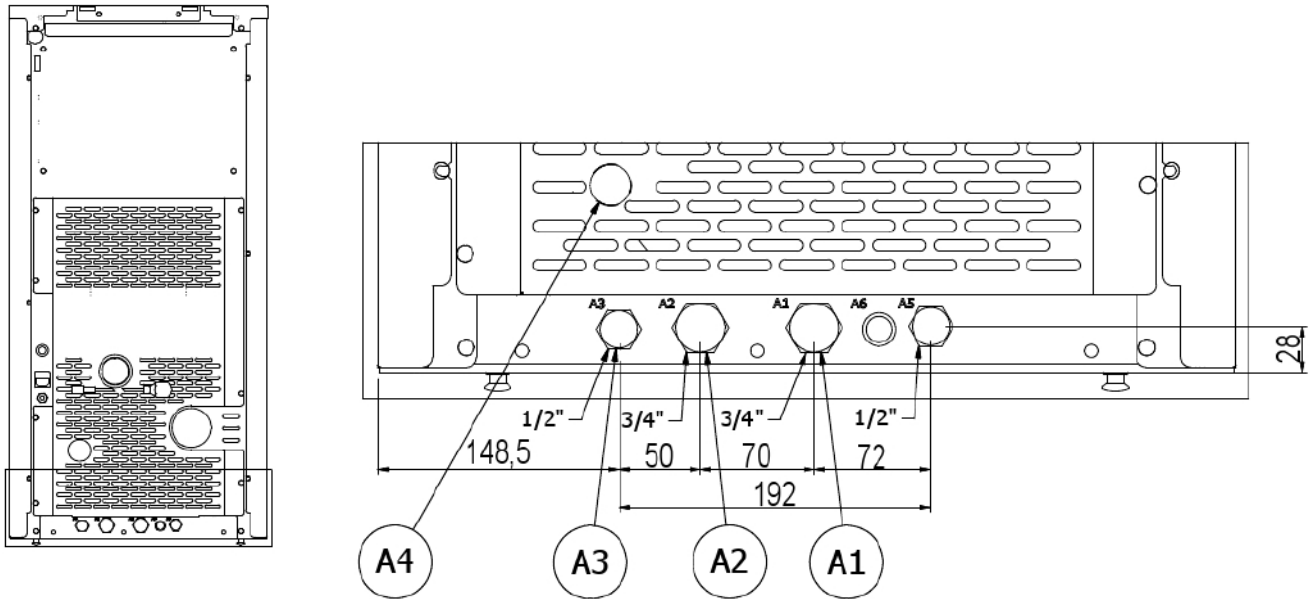

Fig. 35 - Connection diagram DHW

LEGEND	Fig. 35
A1	3/4" M heating water delivery
A2	3/4" M heating water return
A3	System filling / sanitary water inlet
A4	System draining
A5	Domestic hot water outlet

7.4 3 BAR DISCHARGE VALVE

There is a safety valve that can be inspected on the back of the stove under the pump. IT IS MANDATORY to connect a rubber hose that is resistant to temperatures up to 110°C (not supplied) to the safety exhaust and run it to the outside in case water is discharged.



The manufacturer of the appliance is not liable for any flooding caused by the safety valves tripping if they are not properly coupled to the outside of the product or to an appropriate collection and extraction system.

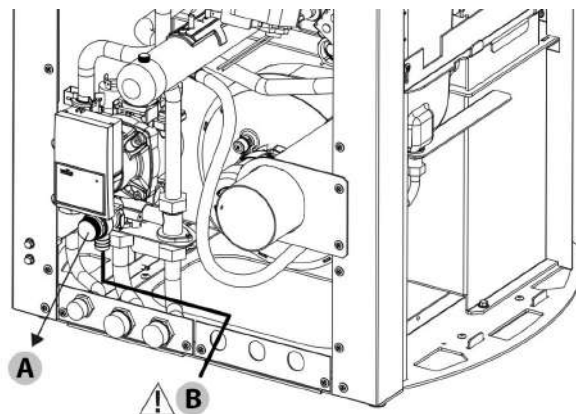

Fig. 36 - Discharge valve

LEGEND	Fig. 36
A	3 bar CE PN10, TMAX 110°C safety valve
B	ATTENTION: 110°C!!

7.5 WASHING THE SYSTEM

The connections must be easy to disconnect via pipe unions with swivel fittings.

Install suitable gate valves on the heating system pipes. A safety valve must be installed on the system.

To protect the heating system from harmful corrosion, build-ups or deposits, it is extremely important before installing the appliance to wash the system in compliance with the UNI 8065 standard (water treatment in heating systems for domestic use), using appropriate products.

The use of FERNOX PROTECTOR F1 (available at our authorised centres) product is recommended, this provides long-term protection of heating systems against corrosion and calcium build-up. It prevents the corrosion of the metal parts of the appliance, i.e. the ferrous metals, copper and copper and aluminium alloys. It also reduces the noise produced by the boiler. Refer to the instructions on the product. Cleaning should be performed by a qualified technician.

We also recommend the use of FERNOX CLEANER F3 and LEAK SEALER F4, always available from our authorised distribution centres. FERNOX F3 is a neutral product for rapid and efficient cleaning of heating appliances. It has been designed to eliminate residues, oily deposits and incrustations from existing appliances of all ages. It can help restore the heating efficiency of the boiler and reduce the noise it generates.

FERNOX F4 is intended to be used with all heating appliances to seal micro fractures that cause small and inaccessible leaks.

7.6 FILLING THE SYSTEM

To fill the system, the stove may be equipped with a terminal (optional) with a non-return valve (D) to manually fill the heating system (if there is no terminal, use the filling valve on the main boiler). During this operation, the automatic bleed valve under the top ensures that any air in the system is expelled.

To allow the valve to bleed, we recommend loosening the grey cap by a turn and leaving the red cap tight (see figure). The filling pressure when the system is **COLD** must be **1 bar**. During operation, should system pressure drop (due to the gas dissolved in the water evaporating) below the above indicated minimum value, the user must bring it back to the initial value, using the filling valve.

For proper stove operation when it is **HOT**, pressure in the boiler must be **1.5 bar**.

To monitor system pressure, the terminal (optional) is equipped with a pressure gauge (M).

When filling is complete, always shut off the valve.



Fit the system with a 2 bar safety valve connected to an accessible outlet.



It is normal for there to be noises and gurgling until all the air in the system has been expelled.

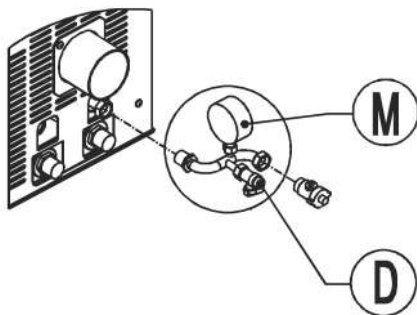

Fig. 37 - Terminal with filling valve (D) and pressure gauge (M)

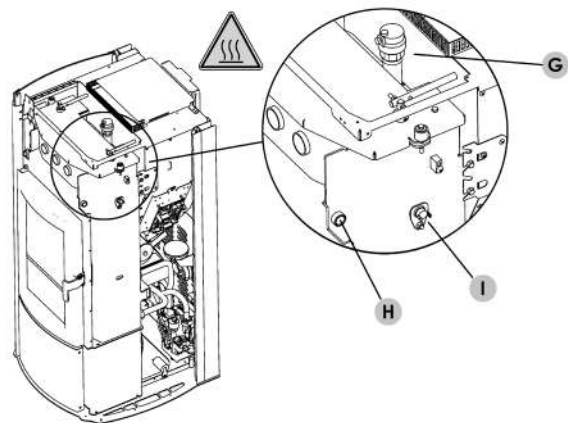

Fig. 38 - Manual bleed valve (located under the top) (Idro Prince³ 16-23-23 H2O, Aquos³ 16-23-23 H2O, Idron 16-22 Airtight, Hidrofire 22.8)

SETTING	VALUES
H	Water temperature probe
I	Flue gas temperature probe
G	Air venting valve

7.7 WATER CHARACTERISTICS

The characteristics of the water used to fill the system are very important to prevent the build-up of mineral salts and the formation of incrustations along the pipes, in the boiler and in the heat exchangers.

Therefore, please ASK YOUR PLUMBER FOR HIS ADVICE CONCERNING:



Hardness of water circulating in the system, to prevent problems of incrustation and limescale, especially in the domestic water heat exchanger. (> 25° French).

Installation of a water softener (if water hardness exceeds 25° French).

Filling the system with treated water (demineralised).

Possibly providing an anti-condensation circuit.

Installation of hydraulic shock absorbers to prevent water hammering along the fittings and pipes.

If you have very extensive systems (with a large amount of water) or which require frequent refilling, the installation of water softening systems.



It should be remembered that incrustations drastically reduce performance due to their extremely low thermal conductivity.

7.8 SYSTEM CONFIGURATION

Upon installation, the product must be set according to the type of system, selecting the appropriate parameter in the “SETTINGS” menu.

The possible configurations are 5, as described below:

CONFIGURATION	DESCRIPTION
1	Room temperature management via probe on the stove or by enabling an external room thermostat.
2	2.1 Room temperature management via probe on the stove or by enabling an external room thermostat: instantaneous DHW production with INTEGRATED plate exchanger.
	2.2 Room temperature management via probe on the stove or by enabling an external room thermostat; DHW production for boiler or storage tank with EXTERNAL thermostat CONNECTED TO THE ELECTRONIC BOARD (optional). DISCONNECT ANY 3-WAY VALVES AND INTERNAL FLOW SWITCHES
3	Room temperature management via probe on the stove or by enabling an external room thermostat; DHW production for boiler OR STORAGE TANK with ntc probe CONNECTED TO THE ELECTRONIC BOARD (10 kΩ B3435). DISCONNECT ANY 3-WAY VALVES AND INTERNAL FLOW SWITCHES
4	External Puffer management controlled by thermostat CONNECTED TO THE ELECTRONIC BOARD.
5	External Puffer management controlled by ntc probe CONNECTED TO THE ELECTRONIC BOARD (10 kΩ B3435).
1-2-3-4-5	Example of connection with AUXILIARY GAS wall-mounted boiler

Following the explanations of the previous chapter, here are the various system configurations to make it easier to recognise the system the boiler is installed on and avoid an incorrect selection. We have indicated which parameters are automatically activated, disabled or blocked for each configuration.

7.9 CONFIGURATION 1

7.9.1 System with: direct pellet stove and room probe or external thermostat** (optional)



All activities relating to electrical connections in the electronic board must be carried out by authorised personnel.



**** If the external thermostat is used, activate the “EXT THERMOSTAT” function on the control panel and connect it directly to the electronic board (see electrical system below).**

Adjustable settin

SETTING	VALUES
ROOM TEMP.	5°C - 35°C
WATER TEMP.	30°C - 80°C

Parameters to set

SETTING	VALUES
CONFIGURATION	1

Hydraulic diagram

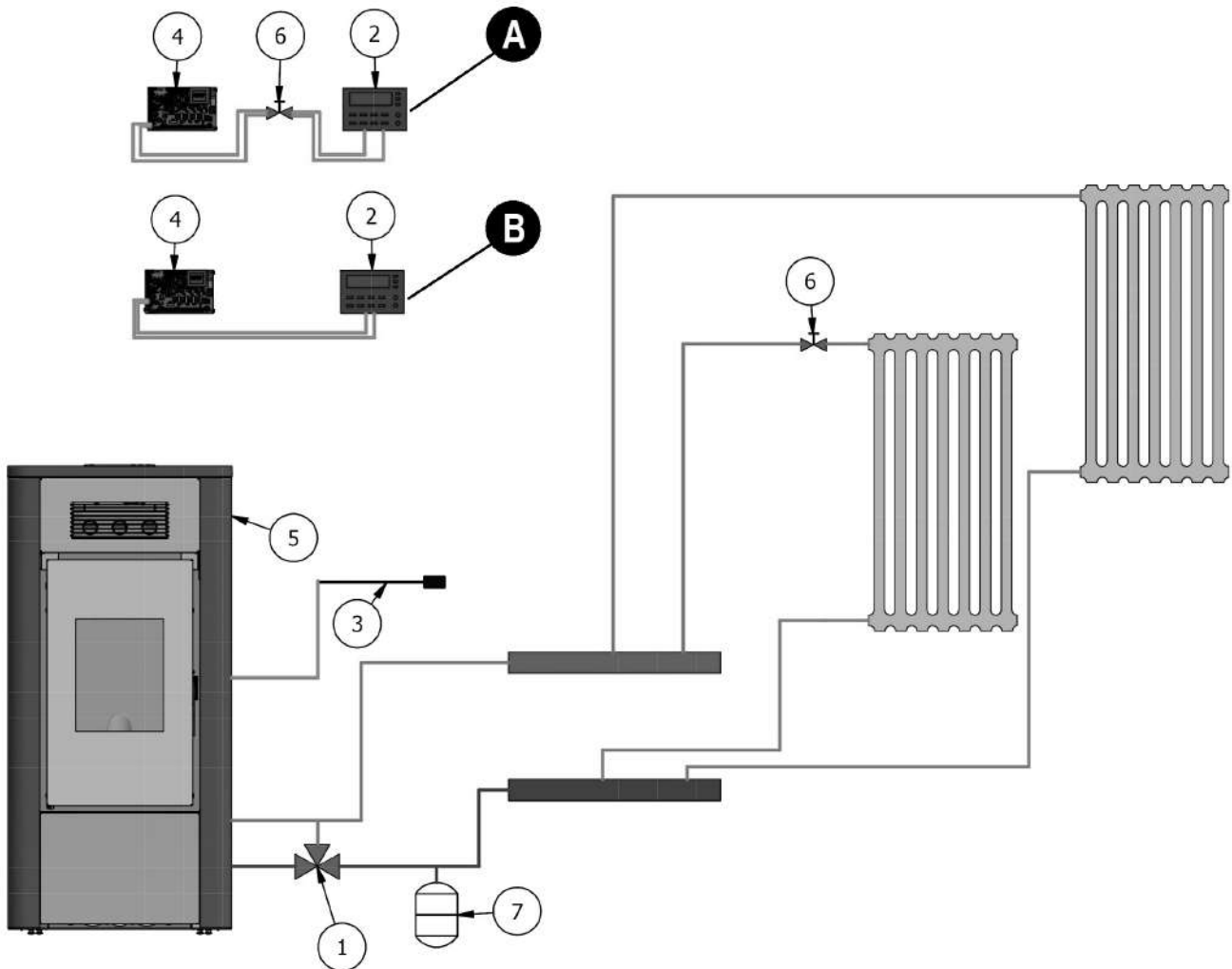

Fig. 39 - Configuration 1

LEGEND	Fig. 39
1	Anti-condensation valve
2	External thermostat
3	Room probe
4	Electronic board
5	Stove
6	Zone valve
7	Expansion vessel
A	Wiring diagram for connecting external thermostat and zone valve (in the case of several valves, connect in parallel)
B	Wiring diagram for connecting the external thermostat

7.10 CONFIGURATION 2

7.10.1 System with: direct pellet stove and room probe or external thermostat** (optional) with internal DHW production



All activities relating to electrical connections in the electronic board must be carried out by authorised personnel.



** If the external thermostat is used, activate the "EXT THERMOSTAT" function on the control panel and connect it directly to the electronic board (see electrical system below).

Adjustable setting

SETTING	VALUES
ROOM TEMP.	5°C - 35°C
WATER TEMP.	30°C - 80°C
DHW TEMP	75°C
SEASON	WINTER (summer may be activated)
AUTO ECO	OFF (with winter setting) ON (with summer setting, cannot be deactivated)

Parameters to set

SETTING	VALUES
CONFIGURATION	2

Hydraulic diagram

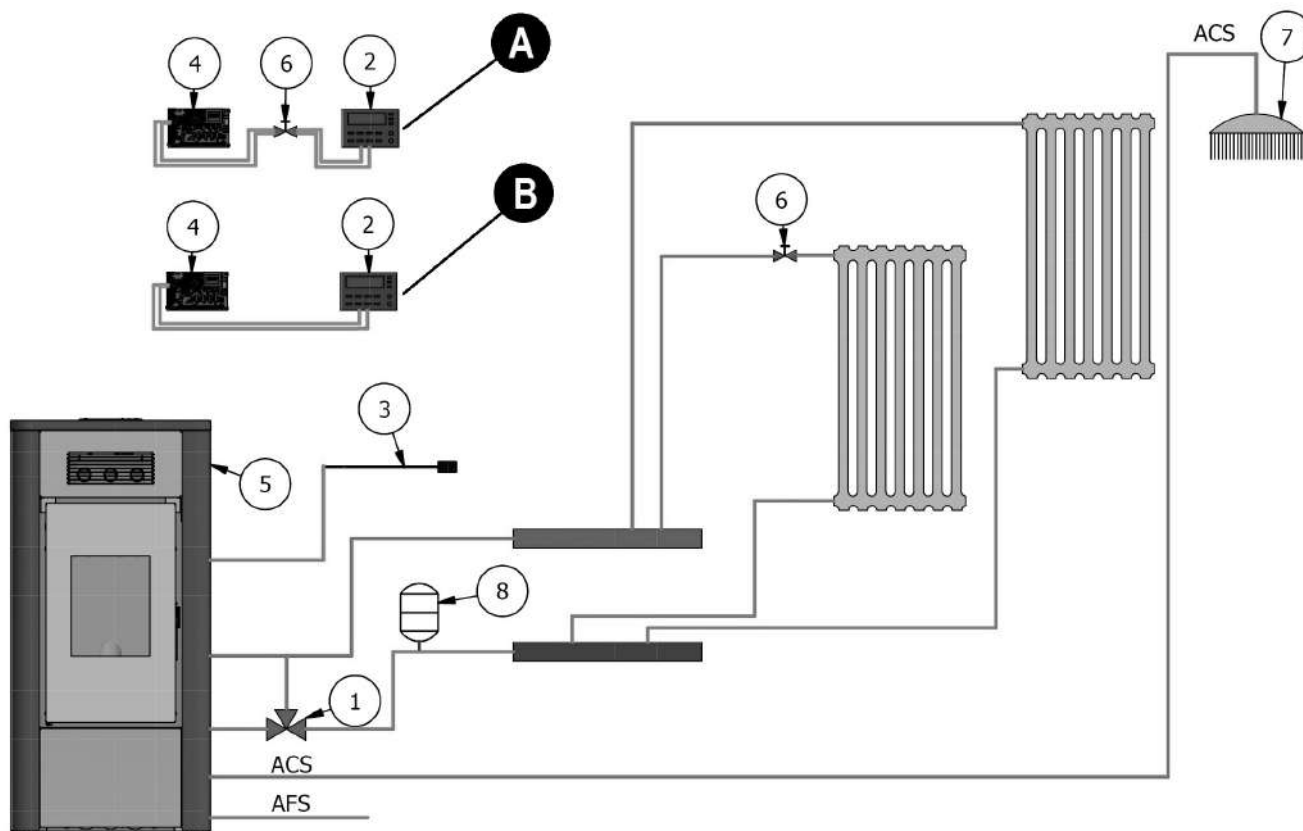

Fig. 40 - Configuration 2

LEGEND Fig. 40

1	Anti-condensation valve
2	External thermostat
3	Room probe
4	Electronic board
5	Stove
6	Zone valve
7	DHW
8	Expansion vessel
A	Wiring diagram for connecting external thermostat and zone valve (in the case of several valves, connect in parallel)
B	Wiring diagram for connecting the external thermostat

7.10.2 System with: direct pellet stove and room probe or external thermostat** (optional) with external DHW production controlled by external thermostat (optional)



All activities relating to electrical connections in the electronic board must be carried out by authorised personnel.



** If the external thermostat is used, activate the "EXT THERMOSTAT" function on the control panel and connect it directly to the electronic board (see electrical system below).

Adjustable setting

SETTING	VALUES
ROOM TEMP.	5°C - 35°C
WATER TEMP.	30°C - 80°C
DHW TEMP	75°C
SEASON	WINTER (summer may be activated)
AUTO ECO	OFF (with winter setting)
	ON (with summer setting, cannot be deactivated)

Parameters to set

SETTING	VALUES
CONFIGURATION	2

Hydraulic diagram

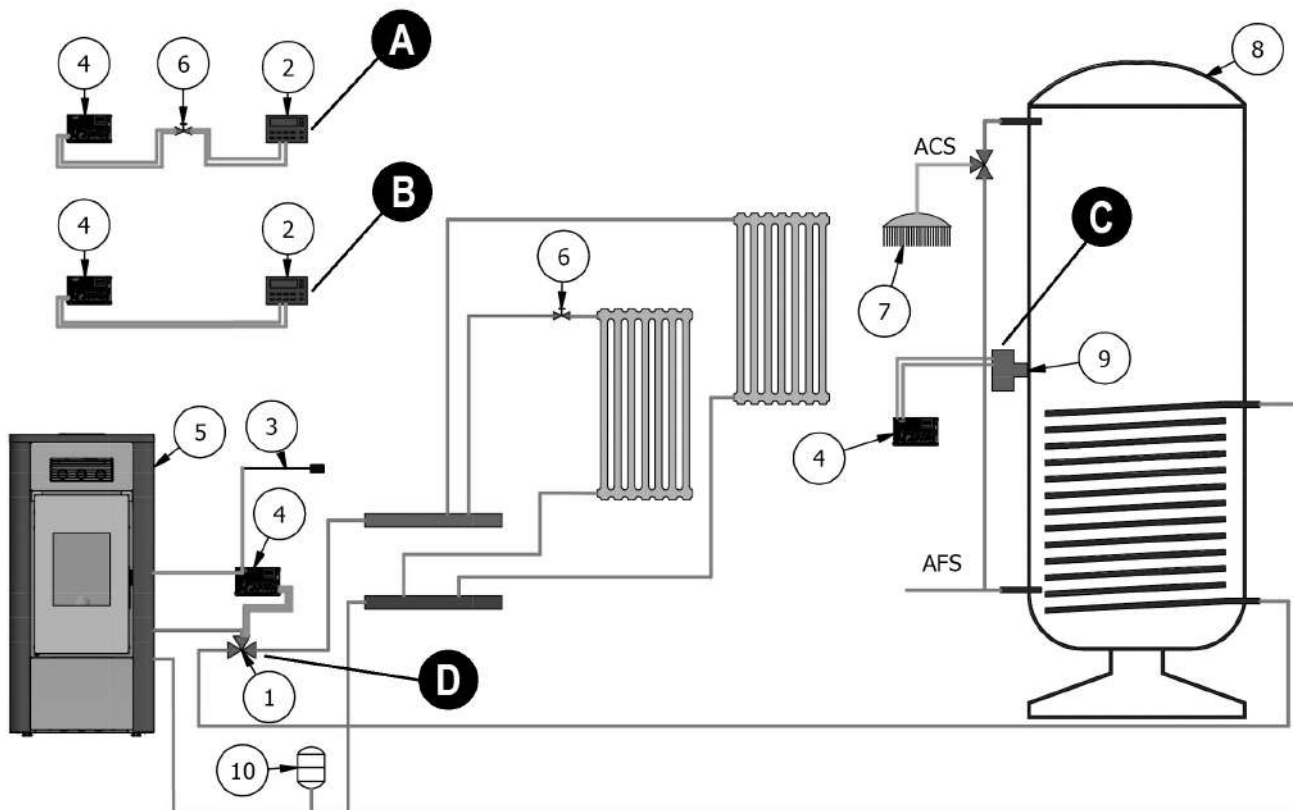

Fig. 41 - Configuration 2

LEGEND Fig. 41

1	Anti-condensation valve
2	External thermostat
3	Room probe
4	Electronic board
5	Stove
6	Zone valve
7	DHW
8	Storage tank
9	Thermostat bulb
10	Expansion vessel
A	Wiring diagram for connecting external thermostat and zone valve (in the case of several valves, connect in parallel)
B	Wiring diagram for connecting the external thermostat
C	Thermostat to be connected directly to the electronic board (see electrical system)
D	3-way valve to be connected directly to the electronic board (see electrical system)



Disconnect any three-way valve and stove internal flow switch, if equipped with a DHW kit.

7.11 CONFIGURATION 3

7.11.1 System with: direct pellet stove and room probe or external thermostat** (optional) with external DHW production controlled by box probe (optional)



All activities relating to electrical connections in the electronic board must be carried out by authorised personnel.



**** If the external thermostat is used, activate the "EXT THERMOSTAT" function on the control panel and connect it directly to the electronic board (see electrical system below).**

Adjustable setting

SETTING	VALUES
ROOM TEMP.	5°C - 35°C
WATER TEMP.	30°C - 80°C
DHW TEMP	75°C
SEASON	WINTER (summer may be activated)
AUTO ECO	OFF (with winter setting) ON (with summer setting, cannot be deactivated)

Adjustable setting

SETTING	VALUES
CONFIGURATION	3

Hydraulic diagram

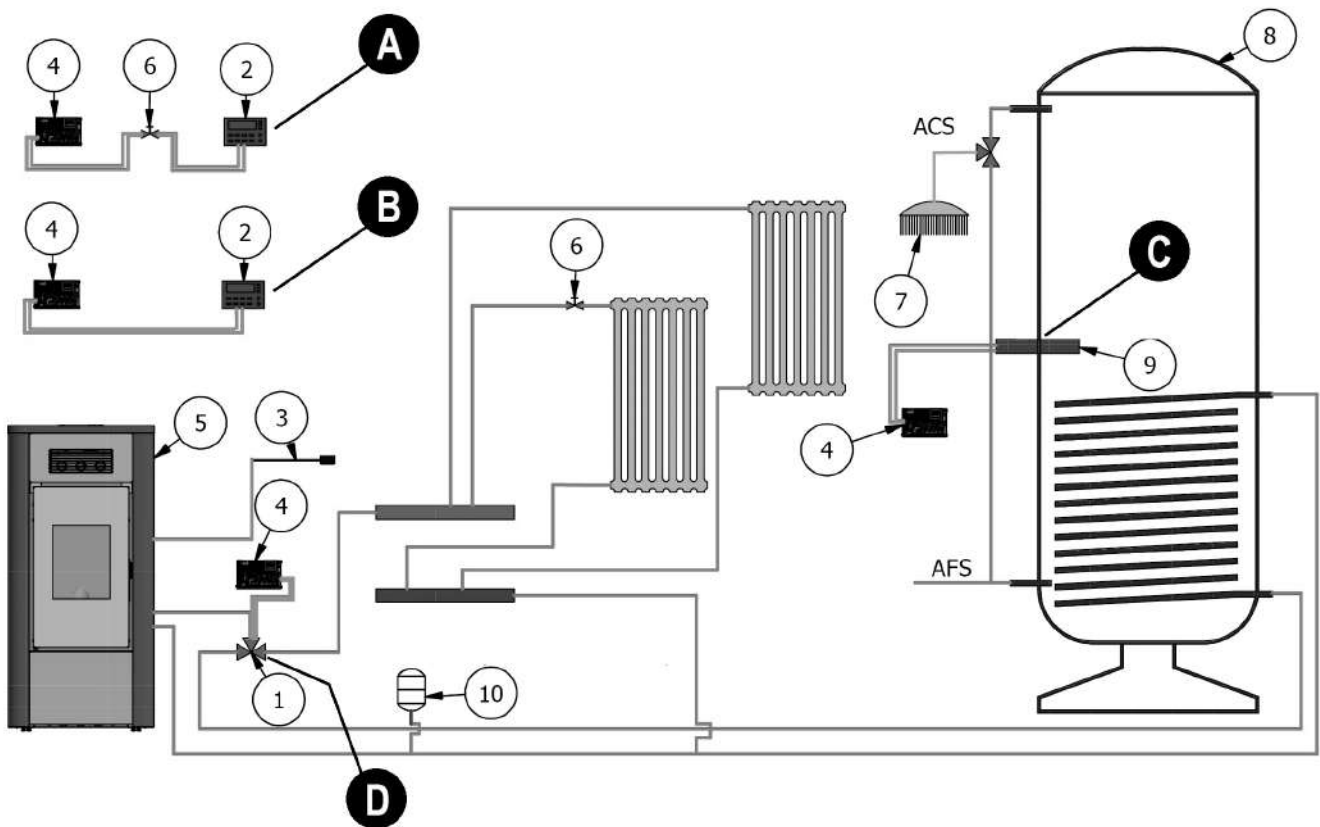

Fig. 42 - Configuration 3

LEGEND	Fig. 42
1	Anti-condensation valve
2	External thermostat
3	Room probe
4	Electronic board
5	Stove
6	Zone valve
7	DHW
8	Storage tank
9	Box NTC probe
10	Expansion vessel

LEGEND Fig. 42

A	Wiring diagram for connecting external thermostat and zone valve (in the case of several valves, connect in parallel)
B	Wiring diagram for connecting the external thermostat
C	NTC probe to be connected directly to the electronic board (see electrical system)
D	3-way valve to be connected directly to the electronic board (see electrical system)



Disconnect any three-way valve and stove internal flow switch, if equipped with a DHW kit.

7.12 CONFIGURATION 4

7.12.1 System with: pellet stove connected directly to a storage tank for maintaining the temperature set and controlled through a thermostat connected to it



All activities relating to electrical connections in the electronic board must be carried out by authorised personnel.

Adjustable setting

SETTING	VALUES
ROOM TEMP.	Cannot be activated
EXTERNAL THERMOSTAT	ON (connect storage tank thermostat)
SEASON	WINTER (summer cannot be activated)
AUTO ECO	ON (it may not be disabled)
BOILER WATER TEMP. SETTING	80 °C (to be adjusted according to the temperature chosen for the storage tank)

Parameters to set

SETTING	VALUES
CONFIGURATION	4

Hydraulic diagram

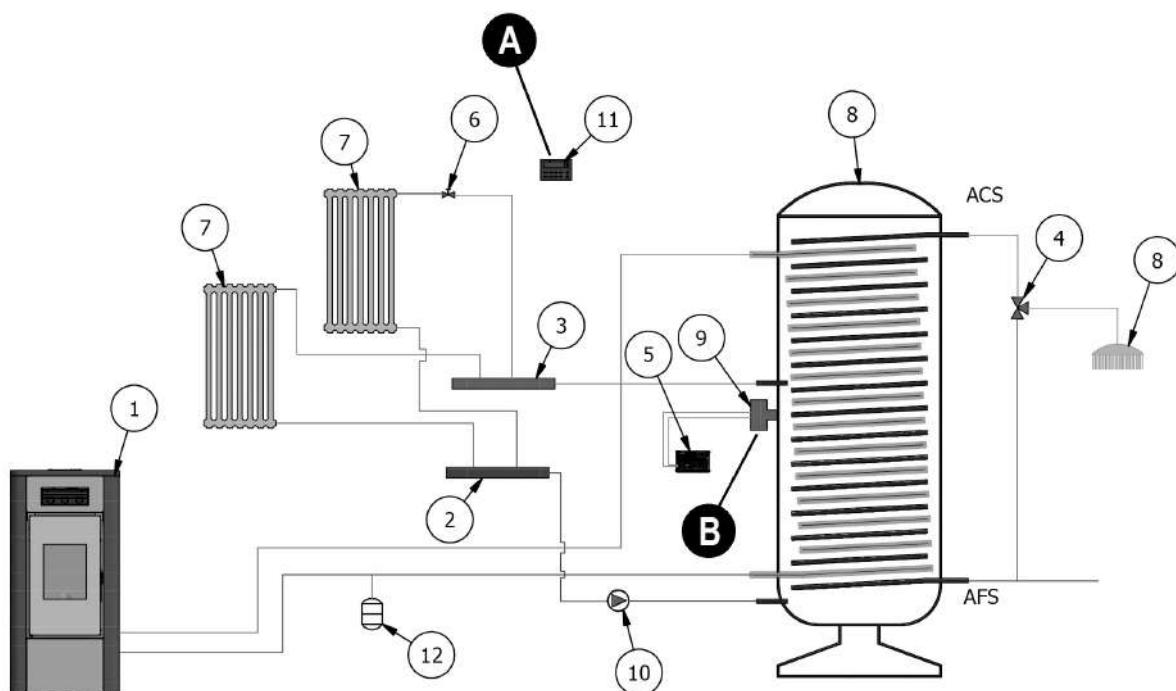

Fig. 43 - Configuration 4

LEGEND Fig. 43

1	Stove
2	Cold H2O manifold
3	Hot H2O manifold
4	3-way valve
5	Electronic board
6	Zone valve
7	Radiator
8	Storage tank
9	Thermostat
10	Release pump
11	Room thermostat
12	Expansion vessel
A	Room thermostat independent from the stove (to be connected to the zone valves, if necessary)
B	Thermostat to be connected directly to the electronic board (see electrical system)



Disconnect any three-way valve and stove internal flow switch, if equipped with a DHW kit.

7.13 CONFIGURATION 5

7.13.1 System with: pellet stove connected directly to a storage tank for maintaining the temperature set and controlled through a thermostat connected to it



All activities relating to electrical connections in the electronic board must be carried out by authorised personnel.

Adjustable setting

SETTING	VALUES
ROOM TEMP.	Cannot be activated
EXTERNAL THERMOSTAT	ON (connect storage tank probe)
SEASON	WINTER (summer cannot be activated)
AUTO ECO	ON (it may not be disabled)
BOILER WATER TEMP. SETTING	80 °C (to be adjusted according to the temperature chosen for the storage tank)

Parameters to set

SETTING	VALUES
CONFIGURATION	5

Hydraulic diagram

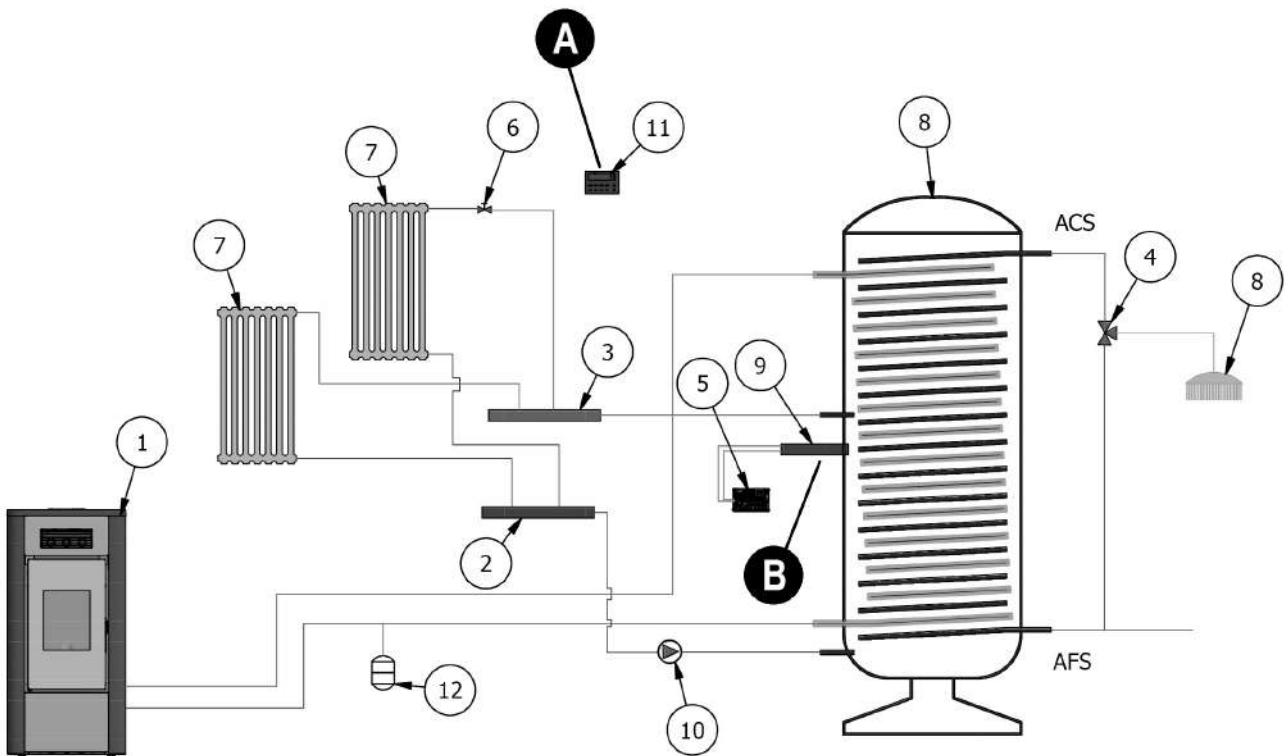

Fig. 44 - Configuration 5

LEGEND Fig. 44

1	Stove
2	Cold H2O manifold
3	Hot H2O manifold
4	3-way valve
5	Electronic board
6	Zone valve
7	Radiator
8	Storage tank
9	NTC probe
10	Release pump
11	Room thermostat
12	Expansion vessel
A	Room thermostat independent from the stove (to be connected to the zone valves, if necessary)
B	NTC probe to be connected directly to the electronic board (see electrical system)



Disconnect any three-way valve and stove internal flow switch, if equipped with a DHW kit.

7.14 CONFIGURATION WITH STORAGE TANK AND AUXILIARY WALL-MOUNTED BOILER (EXAMPLE)

7.14.1 System with: pellet stove connected to a storage tank with auxiliary wall-mounted boiler



All activities relating to electrical connections in the electronic board must be carried out by authorised personnel.

Parameters to set

SETTING	VALUES
CONFIGURATION	1 - 2 - 3 - 4 - 5
AUXILIARY BOILER	ON

Hydraulic diagram

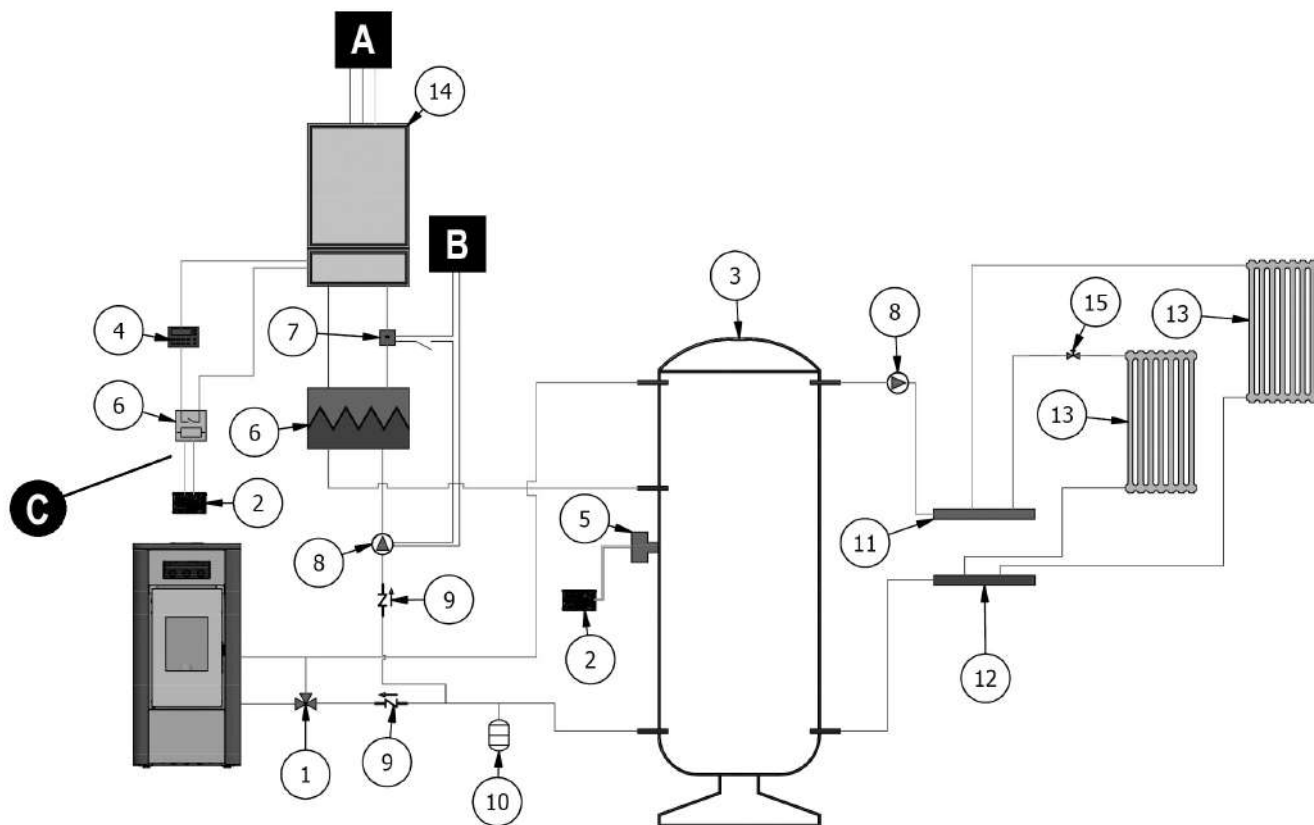

Fig. 45 - Configuration with storage tank and auxiliary wall-mounted boiler

LEGEND Fig. 45

1	Anti-condensation valve
2	Electronic board
3	Storage tank
4	Room thermostat
5	Storage tank thermostat
6	Switch box
7	Strap-on thermostat
8	Booster Pump
9	Non-return valve
10	Expansion vessel
11	Hot H ₂ O manifold
12	Cold H ₂ O manifold
13	Radiator
14	Auxiliary boiler
15	Zone valve
A	Boiler power supply
B	Auxiliary system pump supply
C	Alarm signal

7.15 OPERATING MODE

The operating mode for hydro boilers is AUTOMATIC only (manual mode is not envisioned). Flame modulation is managed according to the "System configuration" of the room probe placed on the rear of the appliance (see drawing), by the external thermostat, by the boiler water temperature or by the NTC probes.

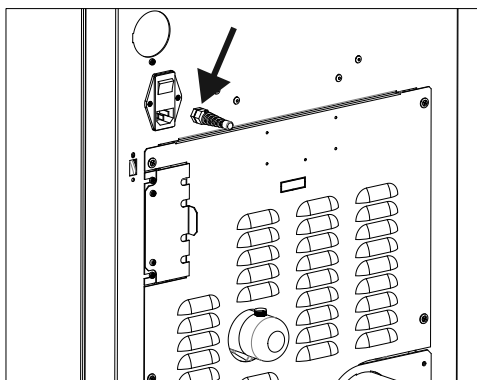

Fig. 46 - Probe position

7.16 ELECTRICAL CONNECTIONS

Terminal board contacts (see **TECHNICAL DATAS** a pag. 41):

N°	CONTACTS
21 - 21	EXTERNAL THERMOSTAT/PUFFER THERMOSTAT
24 - 24	PUFFER/BOILER PROBE
14 - 15	ADDITIONAL BOILER
12	3-WAY VALVE NEUTRAL
33	3-WAY VALVE PHASE (DHW)
34	3-WAY VALVE PHASE (heating)

The connections to the terminal board must be made with cables with a maximum length of 3 metres (regardless of whether they are signal or power cables).



Fig. 47 - Unscrew side



Fig. 48 - Remove side



Fig. 49 - Connections

REAR PANEL

If maintenance must be performed on a component of the stove, the rear panel can be removed (if the distances from the walls allow it), otherwise, the maintenance can be performed by removing the side of the stove. To remove the rear panel, remove the seven rear screws "a" and pull panel "L" away.

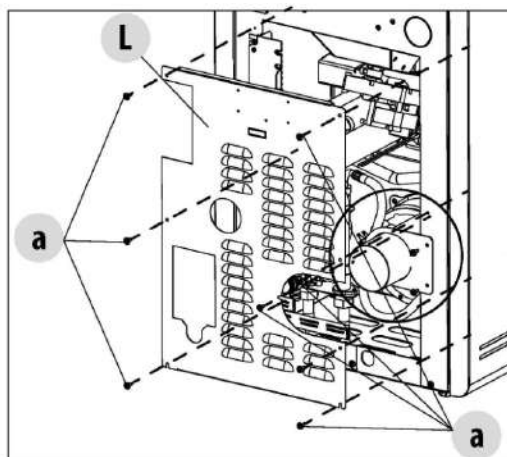

Fig. 50 - back panel

8 SPECIAL MAINTENANCE

8.1 INTRODUCTION

For a long working life of the stove, have a periodic cleaning of the stove as described in the following paragraphs.

- Fume outlet pipes (fume conduit + chimney flue + chimney pot) must always be cleaned, scrubbed and checked by an authorized technician in compliance with local regulations, with the instructions of the manufacturer and those of your insurance company.
- If there are no local regulations and no instruction from your insurance company, it is necessary to have your fume pipe, chimney flue and chimney pot cleaned at least once a year.
- It is also necessary to have the combustion chamber, motors and fans cleaned and to have the gaskets and the electrical elements checked at least once a year.



All these operations must be planned in time with your Authorized Technical Assistance Service.

- After a long ineffective time, before turning on the stove check if there are obstructions in the fume exhaust.
- If the stove had been using continuously and intensely, the whole system (chimney included), must be cleaned and checked more frequently.
- In case of replacement of damaged pieces please ask for the original spare part at the Authorized Retailer.

8.2 DIRTY GLASS

If the glass gets very dirty and the stove is not installed in a sealed chamber, there is the possibility of opening an air slot by removing the top profile of the glass.



Fig. 51 - Undo the 3 screws



Fig. 52 - Remove the profile

8.3 FUME CONDUIT CLEANING

The exhaust system must be cleaned every 2/3 months.



Fig. 53 - Fume conduit cleaning

- Remove the inspection lid of the T-union (see Fig. 53).
- Extract the ash which has accumulated in the inner.
- After cleaning repeat the operation in reverse order, checking the condition and efficiency of the gasket, and if necessary replace it.



It is important to sealed the cap otherwise noxious fumes will propagate among the room.

8.4 SMOKE EXTRACTOR COMPARTMENT CLEANING

At the back of ash drawer "D", you will find smoke cover "E", which must be removed to clean the smoke extractor. Therefore:

- loosen screws "s"
- remove smoke cover "E"

At this point, use a vacuum cleaner nozzle to remove the ash and soot that have accumulated in the lower exchanger shown by the arrow. Before reinstalling cover "E", we recommend replacing gasket "F"

Before vacuuming the ash, we recommend cleaning the inner walls of the stove with a scraper.

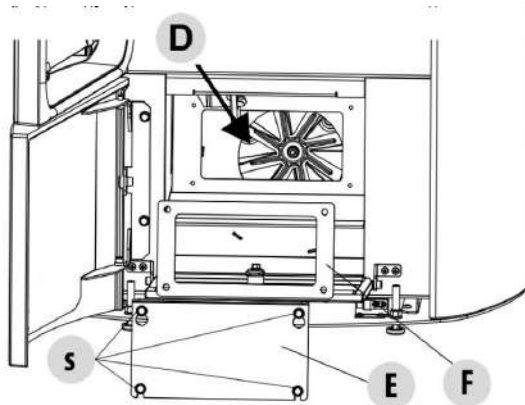

Fig. 54 - Lower compartment cleaning

8.5 CLEANING THE SMOKE EXTRACTION SYSTEM AND GENERAL CHECKS

Clean the smoke exhaust system especially near the "T"-fittings, elbows, and any horizontal sections of the smoke duct.

Contact a qualified chimney sweep to periodically clean the flue.

Check the ceramic fibre gasket seal on the stove door. If necessary, order new gaskets from the dealer for replacement or contact an authorised service centre to perform the entire operation.



ATTENTION:

The fume exhaust system cleaning frequency depends on stove use and its installation.

We recommend contacting an authorised service centre for the end-of-season cleaning and maintenance operations because the centre will perform an overall check of the parts, as well as the above-mentioned operations.

8.6 DOOR CLOSING FUNCTIONALITY PERIODIC CHECK

Check that door closing assures a correct seal (by means of the “paper sheet” test) and that when the door is closed, the closing block (X in the figure) does not protrude from the sheet metal it is fixed to. In some products it will be required to remove the aesthetic coating in order to evaluate any anomalous protrusion of the block with the door closed.

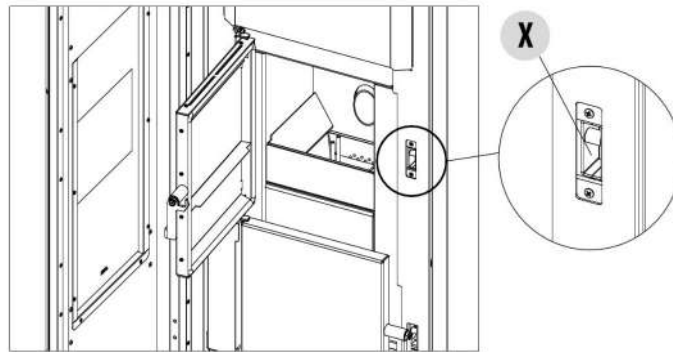

Fig. 55 - Door closing

8.7 FUME PASSAGES CLEANING

Clean the fume passages every year.



Fig. 56 - Remove the screws



Fig. 57 - Remove the inspection cap

- Open the door.



Fig. 58 - Clean with pipe cleaner



Fig. 59 - Vacuum out the ash



Fig. 60 - Clean with pipe cleaner

- Clean with a pipe cleaner and suction any ash accumulated inside
- After cleaning, repeat the operation in reverse making sure the gasket is intact and efficient: if necessary, provide for the replacement with original spare parts.



Fig. 61 - Vacuum out the ash



Fig. 62 - Vacuum out the ash

8.8 CLEANER BLOCKED

If the burn pot grid does not close correctly, the alarm A23 is triggered. Clean the burn pot. Check that there are no pellets stuck between grid and burn pot. (see **Fig. 63**). Break up the pellets using a pointed tool (see **Fig. 64**). Clear the alarm and switch the stove back on.

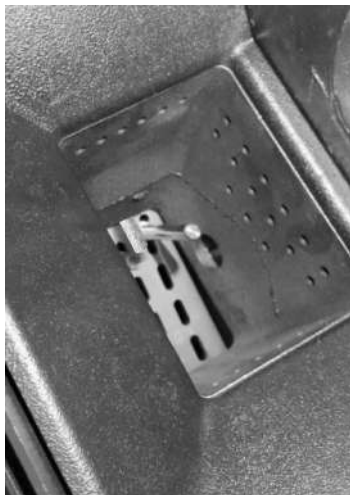

Fig. 63 - Burn pot



Fig. 64 - Burn pot

8.9 REPLACING THE OVERPRESSURE RELIEF VALVE FOR THE COMBUSTION CHAMBER

Combustion chamber overpressure rubber spacer "G" (fig.A) may become worn and/or damaged, thereby requiring replacement once a year to ensure proper system operation.

Replace by following the instructions below:

- Remove the top
- Remove the first ceramic or steel side panel (depending on the type of stove)
- Unscrew the screw-washer-rubber spacer-roller shown in fig.A/C (on both sides of the cover). Then assemble the new kit:
- Align the screw-washer-rubber spacer-roller as shown in fig.C and screw it into the structure.
- Tighten the screw completely.

Now make sure that rubber spacer compression is correct, using the template supplied with the kit:

- Place the template on the cover (fig.B); the head of the screw must barely touch the upper reference. Otherwise, tighten or loosen the screw until it does.

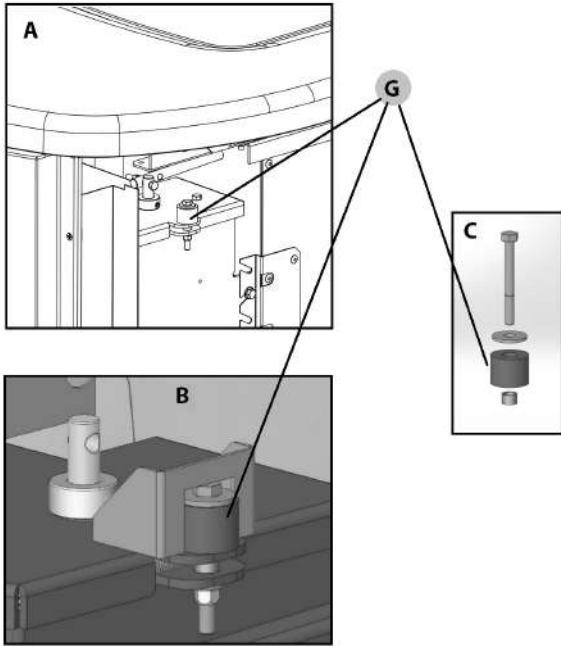

Fig. 65 - Rubber spacer

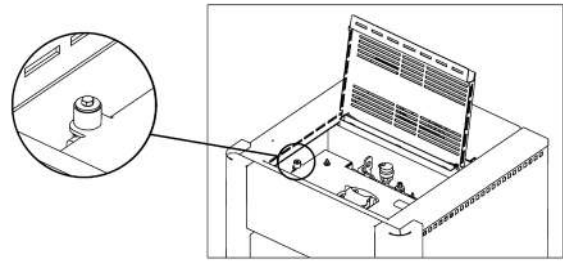

Fig. 66 - Rubber spacer

8.10 FUME PIPES ANNUAL CLEANING

Clean annually from soot with brushes.

The cleaning operation must be executed by a specialized stove-repairer who will provide for the cleaning of fume pipe, chimney flue and chimney pot. He will also check their efficiency and will release a written declaration of the safety of the appliance. This operation must be executed at least once a year.

8.11 GASKET REPLACEMENT

In case of deterioration of fire door, hopper or fume chamber gaskets, it is necessary to replace them by an authorized technician in order to guarantee the good running of the stove.



Use exclusively original spare parts.

9 IN CASE OF ANOMALY











9.1 PROBLEM SOLVING

























Before of every Authorized Technician intervention, the same Technician has the duty to check if the parameters of the mother board correspond to those of the table you own.















In case of doubts regarding the use of the stove, please contact ALWAYS the Authorized Technician on order to avoi irreparable damages!











PROBLEM	CAUSE	SOLUTION	INTERVENTION
The control display does not switch on	The stove is without power supply	Check if the plug is connected.	
	Burned protection fuse in the electric socket	Replace the protection fuses in the electric socket (3.15A-250V).	
	Faulty control display	Replace the control display.	
	Faulty flat cable	Replace the flat cable.	
	Faulty electronic board	Replace the mother board.	
Pellets do not reach the combustion chamber	Empty hopper	Full the hopper.	
	Open fire door or open pellet door	Close fire door and pellet door and check that there are no pellet grains at the gasket level.	
	Clogged stove	Fume chamber cleaning	
	Auger blocked by a foreign object (for example nails)	Clean the auger.	
	The auger geared motor is out of order	Replace the geared motor.	
	Check if on the display there is an "ACTIVE ALARM"	Have the stove checked.	

PROBLEM	CAUSE	SOLUTION	INTERVENTION
The fire extinguish and the stove stops	Empty hopper	Full the hopper.	
	Auger blocked by a foreign object (for example nails)	Clean the auger.	
	Bad quality pellets	Try other types of pellets.	
	Pellet drop value too low "phase 1"	Adjust the pellet loading.	
	Check if on the display there is an "ACTIVE ALARM"	Have the stove checked.	
	The door does not close perfectly or the gaskets are worn	Check the door seal and replace the gaskets.	
	Ignition step is not completed	Empty the brazier and repeat ignition.	
	Clogged exhaust	The exhaust chimney is partially or totally obstructed. Call a skilled chimney technician to check from the stove exhaust to the chimney pot. Clean immediately.	
Flames are weak and orange coloured, pellets do not burn properly and the glass blackens	Not sufficient combustion air	Check as following: probable obstructions of the combustible air inlet from the back or from the bottom of the stove; burning pot obstructed holes with too ash remains. Have the fan blades and auger cleaned. (see SMOKE RPM VARIATION User Manual)	
	Obstructed exhaust	The exhaust chimney is partially or totally obstructed. Contact an expert stove-repairer who checks the stove from the exhaust up to the chimney pot. Provide immediately for stove cleaning.	
	Obstructed stove	Provide immediately at the inner cleaning of the stove.	
	The fume fan is out of order	The pellets can burn also thanks to chimney flue depression without the aid of the fume fan. Have the fume fan immediately replaced. It can be noxious to health to let the stove running without fume fan.	
The exchanger fan continues to turn even though the stove has just cooled	Faulty fume temperature probe	Replace the fume probe.	
	Faulty mother board	Replace the mother board.	

PROBLEM	CAUSE	SOLUTION	INTERVENTION
Ash remains along the stove	Faulty or out of order door gaskets	Replace the gaskets.	
	Not sealed fume pipes	Contact an expert stove-repairer who will immediately provide for sealing the junctions with high-temperature silicone and/or for replacing pipes with those in compliance to current regulations. A not sealed fume channelisation can be noxious to health.	
The stove is at its highest power but does not heat up.	Ambient temperature reached.	The stove is at its minimum value. Increase the desired ambient temperature.	
Stove running and display showing "Smoke Overtemperature"	Reached fume outlet limit temperature	The stove runs at minimum. NO PROBLEM!	
The stove's smoke duct produces condensation	Low smoke temperature	Check that the flue is not clogged.	
		Increase stove power to minimum (pellet drop and fan revs).	
		Install condensation collection cup.	
Stove running and display showing "SERVICE"	Routine maintenance alert (it does not block the system)	When this flashing message appears upon start-up, it means that the preset operating hours have elapsed before maintenance. Contact the service centre.	

9.2 PROBLEM SOLVING (THERMOSTOVE)

PROBLEM	POSSIBLE CAUSES	SOLUTIONS	INTERVENTION
In automatic position, the boiler always works at maximum power	Thermostat set to the minimum	Reset the thermostat temperature.	
	Room thermostat in a position that always detects cold.	Change the position of the thermostat	
	Faulty temperature detection probe.	Check and, if necessary, replace the probe	
	Faulty circuit board	Replace board	
The boiler does not start	Power failure	Make sure the power cable is plugged in and the main switch is in the "I" position.	
	Blown fuse	Replace the fuse.	
	Clogged smoke duct or exhaust	Clean the smoke exhaust and/or smoke duct.	
	Water temperature probe has tripped	Call customer service	
Temperature does not increase with the boiler working	Improper combustion adjustment.	Check recipe and parameters.	
	Dirty boiler/system	Check and clean the boiler.	
	Insufficient boiler power.	Make sure the boiler is appropriately proportional to the system requirements.	
	Poor quality pellets	Use quality pellets	

PROBLEM	POSSIBLE CAUSES	SOLUTIONS	INTERVENTION
WATER ON FLOOR	BOILER EXTERNAL CONDENSATE	Adjust the boiler to a higher temperature	
	NO ANTI-CONDENSATION VALVE	INSTALL ANTI-CONDENSATION VALVE	
	LEAK FROM PIPES	CHECK CLOSURE of the PIPE FITTINGS	
Radiators cold in the winter	Room thermostat (local or remote) adjusted too low. If remote thermostat, check whether it is defective.	Adjust it to a higher temperature. Replace it if necessary (if remote)	
	The circulator does not turn because it is blocked.	Release the circulator by removing the cap and turning the shaft with a screwdriver	
	The circulator does not turn.	Check its electrical connections, replace it if necessary	
	Air inside the radiators	Bleed the radiators	
No HEATING water comes out	Circulator (pump) blocked	Release the circulator (pump)	
	NO PRESSURE in SYSTEM	INCREASE PRESSURE and CHECK FOR LEAKS	
Noise and gurgling	Air in the system	Vent the air and fill the system	
DOMESTIC HOT WATER DOES NOT COME OUT	3-WAY VALVE BLOCKED	CHECK 3-WAY VALVE	

10 TECHNICAL DATAS

10.1 ELECTRONIC BOARD WITHOUT DHW

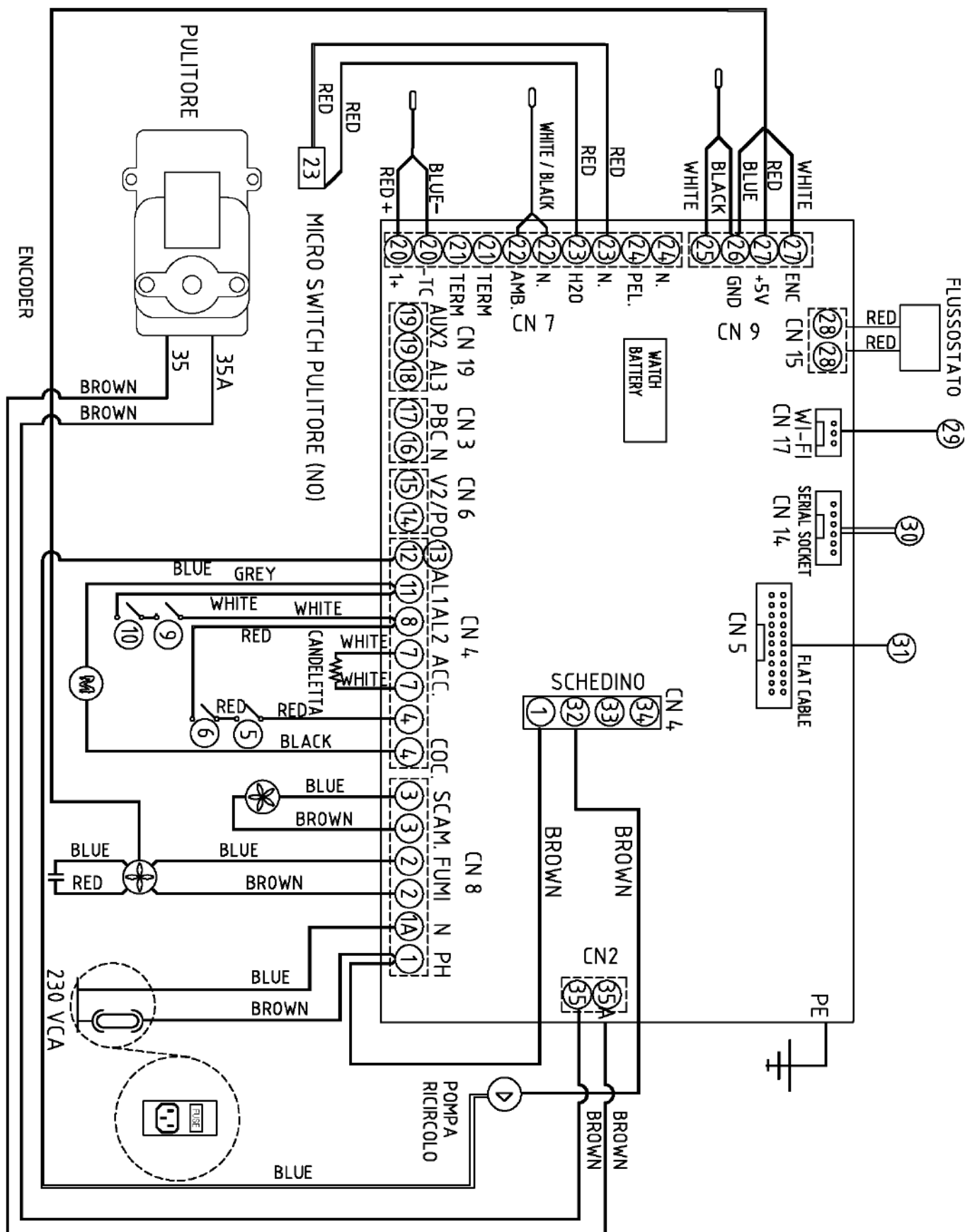

Fig. 67 - Scheda elettronica senza kit sanitario

10.2 ELECTRONIC BOARD WITH DHW

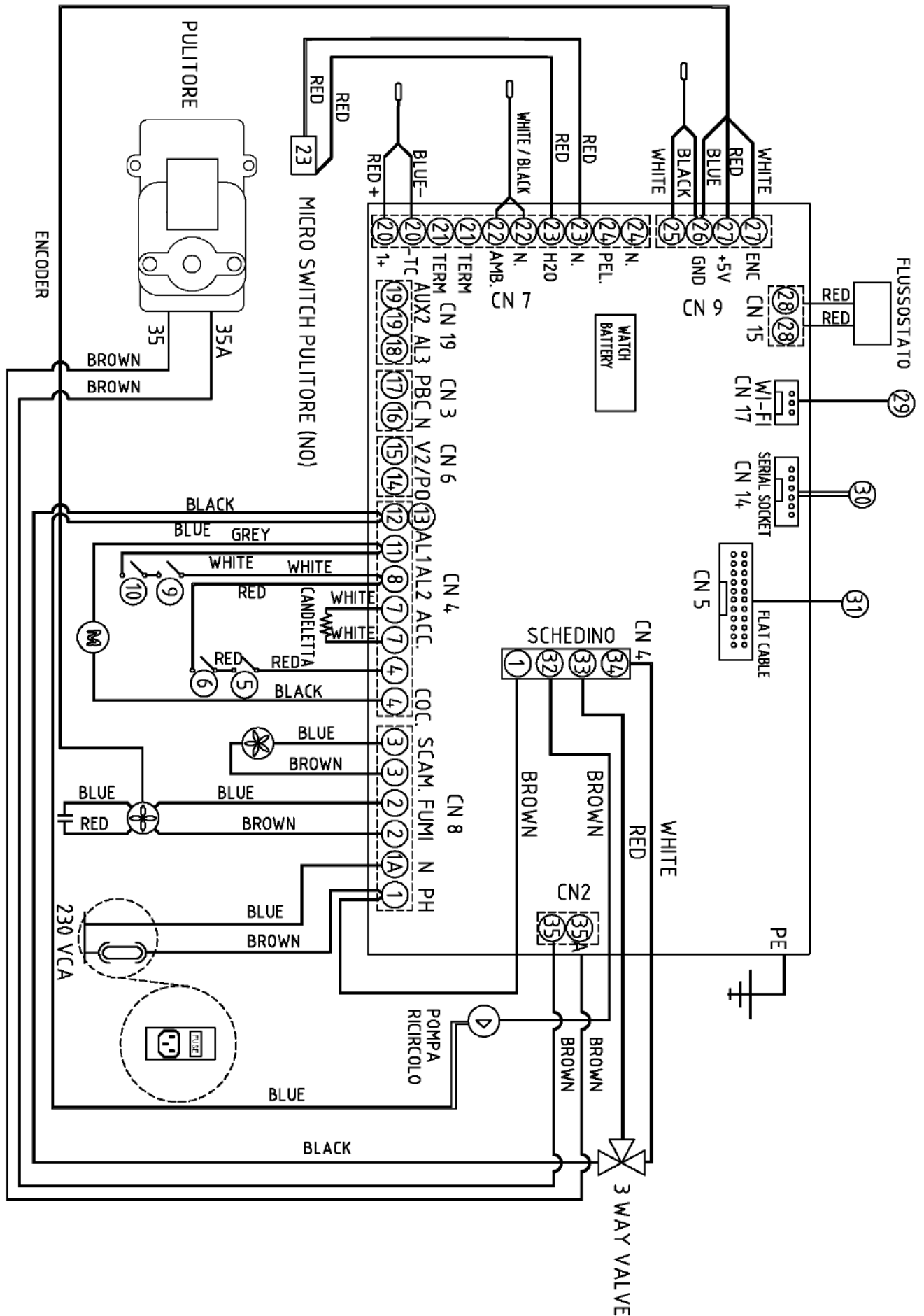

Fig. 68 - Scheda elettronica con kit sanitario

LEGEND	Fig. 67 Fig. 68
1	<i>POWER SUPPLY BOARD</i>
1A	<i>BOARD NEUTRAL</i>
2	<i>Smoke extraction breeze</i>
3	<i>Room fan</i>
4	<i>Feed screw</i>
5	<i>Pellet safety thermostat</i>
6	<i>Water thermal protector</i>
7	<i>GLOW PLUG</i>
8	<i>Alarms input</i>
9	<i>AIR PRESSURE SWITCH</i>
10	<i>WATER PRESSURE SWITCH</i>
11	<i>Alarms input</i>
12	<i>Neutral 3-way Solenoid Valve</i>
13	<i>Neutral recirculation pump</i>
14	<i>Additional boiler control</i>
15	<i>Additional boiler return</i>
16	<i>Neutral</i>
17	<i>-</i>
18	<i>-</i>
19	<i>-</i>
20	<i>SMOKE PROBE</i>
21	<i>EXTERNAL ROOM THERMOSTAT OR FOR BOILER</i>
22	<i>STOVE INTERNAL ROOM PROBE</i>
23	<i>Cleaner micro switch</i>
24	<i>External Puffer_boiler probe</i>
25/26	<i>Boiler H2O temperature probe</i>
26/27	<i>Flue gas fan encoder</i>
28	<i>Flow switch (See note)</i>
29	<i>Wi-Fi connection</i>
30	<i>Interface connection (service)</i>
31	<i>Control panel</i>
32	<i>Recirculation pump phase</i>
33	<i>3-way valve DHW phase</i>
34	<i>3-way valve heating phase</i>
35	<i>Cleaner power supply</i>
35A	<i>Cleaner neutral</i>
28:	<i>Note: external boiler thermostat</i>

N.B. The wiring of the individual components is fitted with pre-wired connectors of different sizes.

10.3 REPAIR INFORMATION

Now we give some instructions for the Authorized Technician to take into consideration to have access to stove mechanical components.

- For fuse replacement in the electric socket which stands on the back of the stove, extract the fuses to change with the aid of a screwdriver for opening the shutter (see **Fig. 69**).



Fig. 69 - Shutter with fuses to remove

Proceed as follows:

- Remove the frame (see the dedicated chapters).
- After these operations you can have access at the following components: geared motor, ignition plug, ambient fan, fume fan, ambient probe, fume probe, thermostat, electronic board, pressostat.
- For cleaning or replacement of the auger it is necessary to unscrew the three bolts of the geared motor and to extract it, unscrew the two screws lying under the geared motor (vedi **Fig. 70**), of the auger, remove the hand rejector inside the hopper and then unscrew the inner bolt of the auger. (vedi **Fig. 71**). To assembly proceed at the contrary.



Fig. 70 - Remove the screws



Fig. 71 - Remove the screw

11 FEATURES

DESCRIPTION	RIVER IDROTECH 18 T1	RIVER IDROTECH 24 T1	RIVER IDROTECH 24H20 T1
WIDTH	53,6 cm	53,6 cm	53,6 cm
DEPTH	55,9 cm	55,9 cm	55,9 cm
HEIGHT	111,5 cm	111,5 cm	111,5 cm
WEIGHT	136 kg	136 kg	136 kg
Effective rated power (H ₂ O)	12,7 kW	18,2 kW	18,2 kW
Minimum effective power (H ₂ O)	2,3 kW	2,3 kW	2,3 kW
Maximum operating pressure	2 bar – 200 kPa	2 bar – 200 kPa	2 bar – 200 kPa
INTRODUCED THERMIC POWER (Min/Max)	4,6 - 18,7 kW	4,6 - 26 kW	4,6 - 26 kW
NOMINAL THERMIC POWER (Min/Max)	4,4 - 17,7 kW	2,6 - 8,5 kW	2,6 - 8,5 kW
EFICIENCY (Min/Max)	95,9 - 94,8 %	95,9 - 92,9 %	95,9 - 92,9 %
FUME TEMPERATURE (Min/Max)	55 - 107 °C	55 - 142 °C	55 - 142 °C
FUME MAXIMUM LOADING CAPACITY (Min/Max)	5,4 - 10,6 g/s	5,4 - 14,2 g/s	5,4 - 14,2 g/s
CO EMISSIONS (13% O ₂) (Min/Max)	0,017 - 0,009 %	0,017 - 0,014 %	0,017 - 0,014 %
OGC EMISSIONS (13% O ₂) (Min/Max)	6 - 2 mg/Nm ³	6 - 1 mg/Nm ³	6 - 1 mg/Nm ³
NO _x EMISSIONS (13% O ₂) (Min/Max)	100 - 99 mg/Nm ³	100 - 92 mg/Nm ³	100 - 92 mg/Nm ³
Medium CO CONTENTS at 13% O ₂ (Min/Max)	209 - 106 mg/Nm ³	209 - 169 mg/Nm ³	209 - 169 mg/Nm ³
Medium POWDER CONTENTS at 13% O ₂ (Min/Max)	12 - 10 mg/Nm ³	12 - 12 mg/Nm ³	12 - 12 mg/Nm ³
CHIMNEY DEPRESSION (Max)	12 Pa - 2 Pa***	12 Pa - 2 Pa***	12 Pa - 2 Pa***
ON SHARED CHIMNEY FLUE	NO	NO	NO
FUME OUTLET DIAMETER	Ø80 mm	Ø80 mm	Ø80 mm
COMBUSTIBLE	Pellet Ø6-7 mm	Pellet Ø6-7 mm	Pellet Ø6-7 mm
PELLETS HEATING VALUE	5 kWh/kg	5 kWh/kg	5 kWh/kg
PELLETS HUMIDITY	≤ 10%	≤ 10%	≤ 10%
HEATING VOLUME 18/20°C Coeff. 0,045 kW (Min/Max)	123 - 496 m ³ ***	123 - 678 m ³ ***	123 - 678 m ³ ***
HOURLY CONSUMPTION (Min/Max)	1 - 3,9 kg/h*	1 - 5,4 kg/h*	1 - 5,4 kg/h*
HOPPER CAPACITY	24 kg	24 kg	24 kg
RANGE (Min/Max)	24 - 6 h	24 - 4 h	24 - 4 h
SUPPLY	230 V - 50 Hz	230 V - 50 Hz	230 V - 50 Hz
POWER INPUT (Max)	370 W	370 W	370 W
INGNITER RESISTANCE POWER INPUT	300 W	300 W	300 W
MINIMUM EXTERNAL AIR INLET (last effective area)	80 cm ²	80 cm ²	80 cm ²
STOVE WITH SEALED CHAMBER	YES	YES	YES
EXTERNAL AIR INLET FOR SEALED CHAMBER	60 mm	60 mm	60 mm
DISTANCE FROM COMBUSTIBLE MATERIAL (back/side/bottom)	200 / 300 / 0 mm	200 / 300 / 0 mm	200 / 300 / 0 mm
DISTANCE FROM COMBUSTIBLE MATERIAL (ceiling/front)	- / 1000 mm	- / 1000 mm	- / 1000 mm

* Values that can vary depending on the type of pellet used

** Heatable volume depending on the power required per m³ (respectively, 40-35-30 Kcal/h per m³)

*** Value recommended by the manufacturer (not binding) for optimal product performance

Tested according to EN 14785 in compliance with the European Construction Product regulation (EU 305/2011)



890221298

Rev. 00 - 2022

CADEL srl
31025 S. Lucia di Piave - TV
Via Foresto sud, 7 - Italy
Tel. +39.0438.738669
Fax +39.0438.73343

www.cadelsrl.com
www.free-point.it
www.pegasoheating.com