

Scan and Login website
for more information



Management
System
EN ISO
13485:2016
www.tuv.com
DE 200000214

Ultrasonography Tip Book



Osteotomy

Model

Unit: mm

Page

SS1

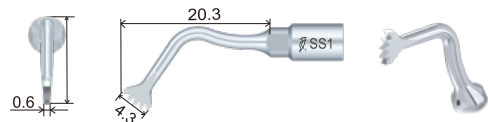

1

SS1L

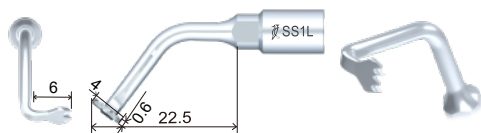

2

SS1R

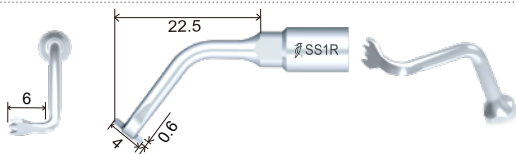

2

SS2

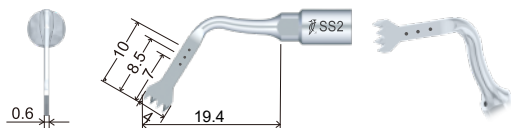

3

SS3

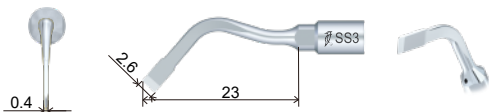

3

Osteotomy

Model

Unit: mm

Page

SS4

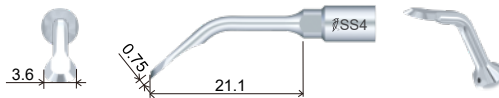

4

SS5

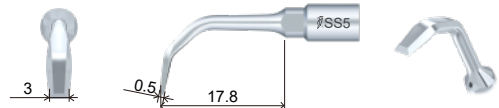

4

SS6

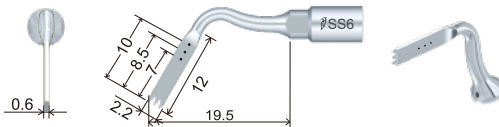

5

SS8

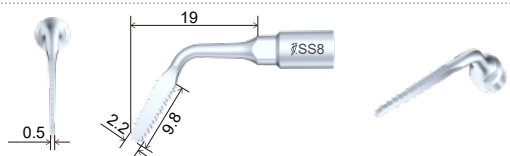

5

SS9

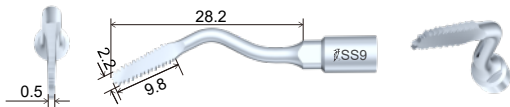

6

Osteotomy

Model

Unit: mm

Page

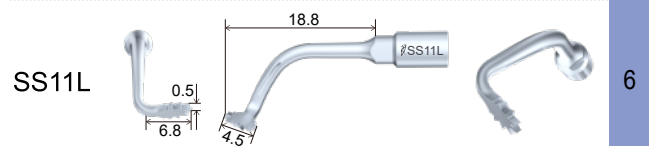

6

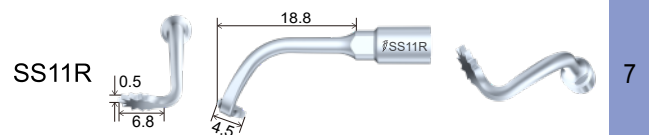

7

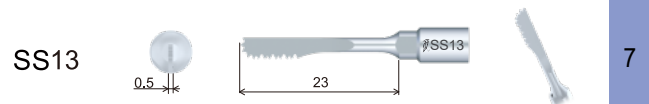

7

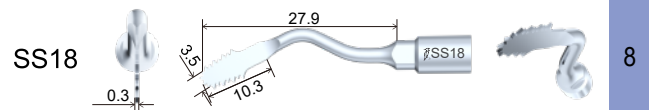

8

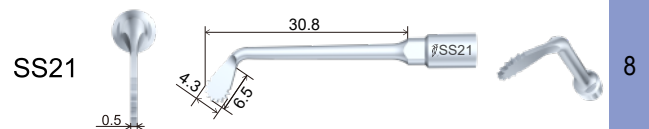

8

Osteotomy

Model

Unit: mm

Page

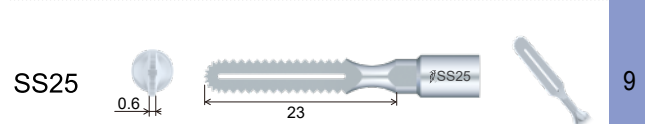

9

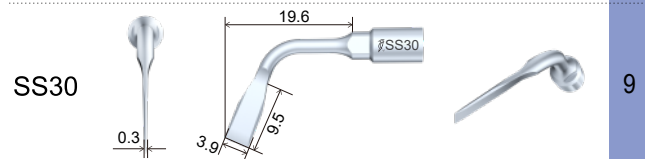

9

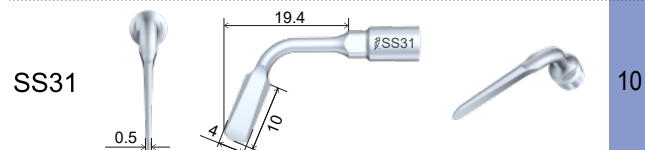

10

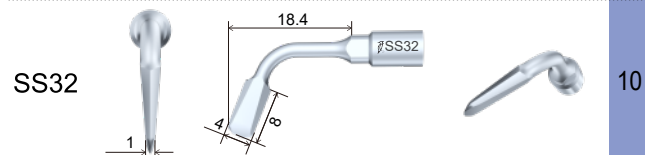

10

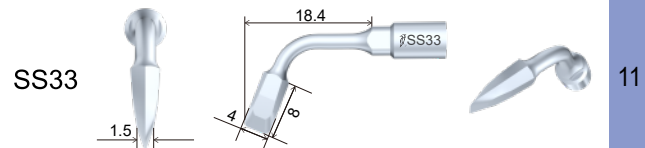

11

Osteotomy

Model

Unit: mm

Page

SS34

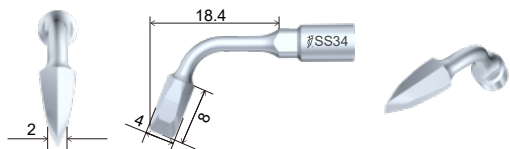

11

Sinus lifting

Model

Unit: mm

Page

SL1

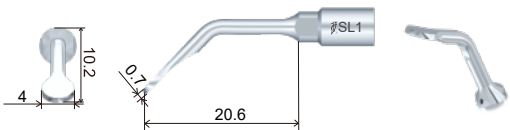

12

SL2

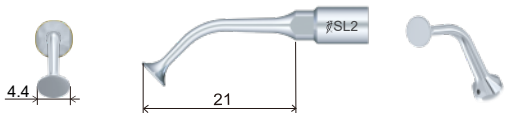

12

SL3

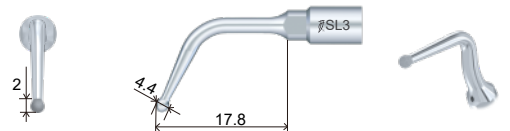

13

Sinus lifting

Model

Unit: mm

Page

SL4

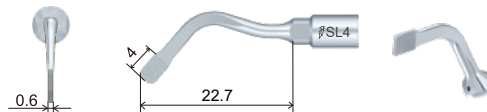

13

SL5

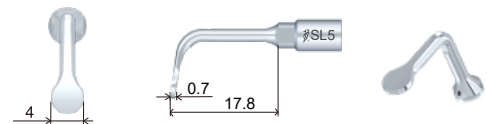

14

SL6

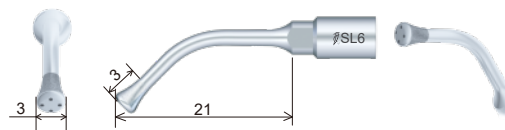

14

SL7

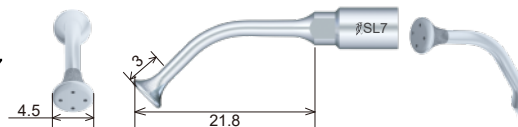

15



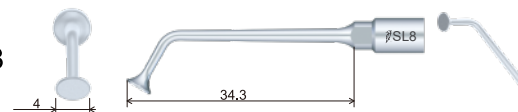

SL8



15

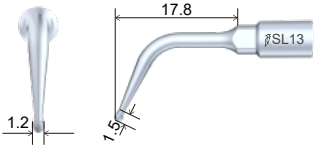

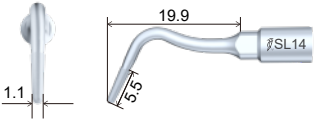

Sinus lifting

Unit: mm
Page

| | | | |
|------|---|---|----|
| SL13 |  |  | 16 |
| SL14 |  |  | 16 |

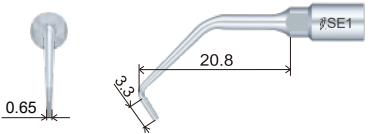

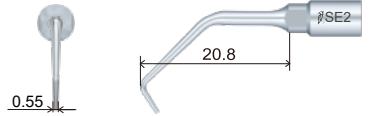





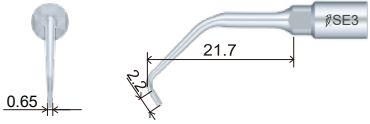

Endodontics Unit

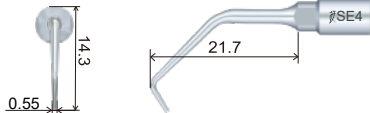
Unit: mm
Page

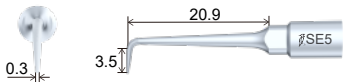
| | | | |
|-----|---|---|----|
| SE1 |  |  | 17 |
| SE2 |  |  | 17 |

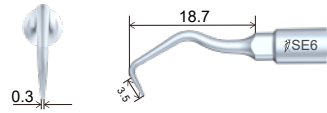
Endodontics Unit

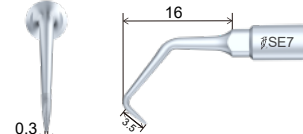
Unit: mm
Page

| | | | |
|-----|--|---|----|
| SE3 |  |  | 18 |
| SE4 |  |  | 18 |
| SE5 |  |  | 19 |
| SE6 |  |  | 19 |
| SE7 |  |  | 20 |

Endodontics Unit

Model

Unit: mm
Page

SE8

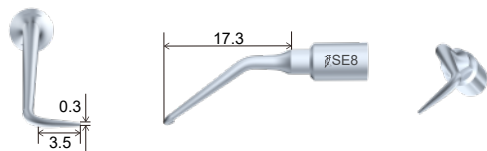

20

SE9

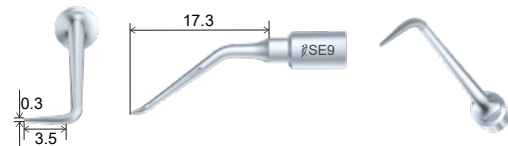

21

Extraction

Model

Unit: mm
Page

SC1

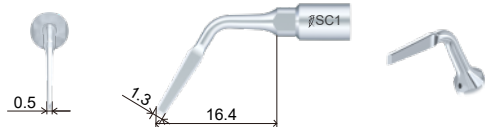

21

SC2

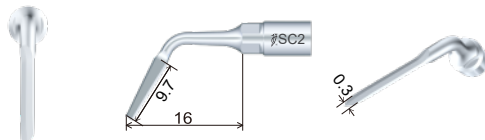

22

Extraction

Model

Unit: mm
Page

SC3

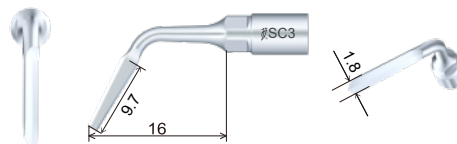

22

SC4

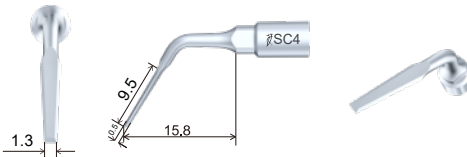

23

SC5

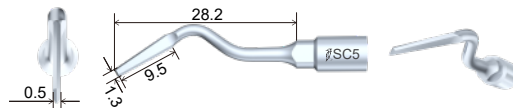

23

SC6

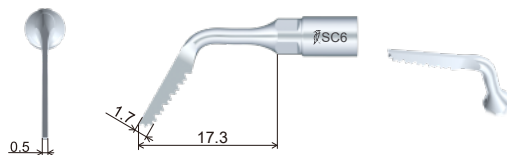

24

SC7

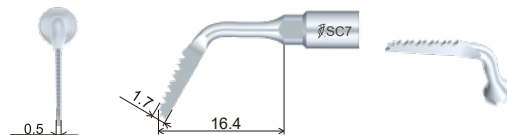

24

Extraction

Model

Unit: mm

Page

SC8

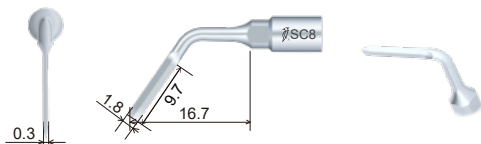

25

Implantation

Model

Unit: mm

Page

SI1

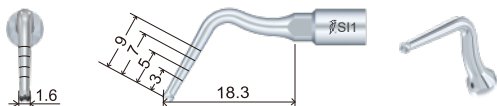

25

SI2

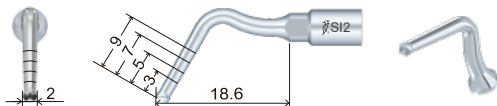

26

SI3

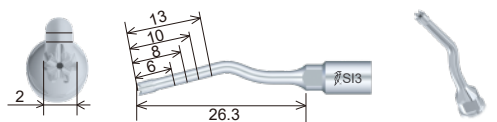

26

Implantation

Model

Unit: mm

Page

SI4

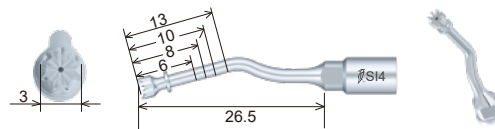

27

SI5

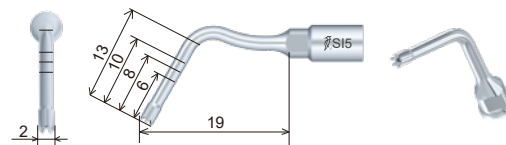

27

SI6

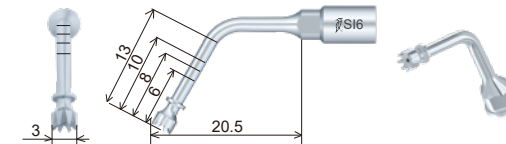

28

SI7

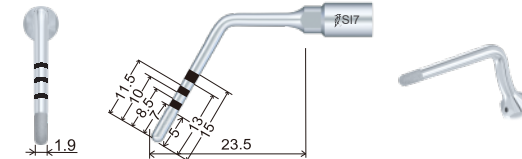

28

SI8

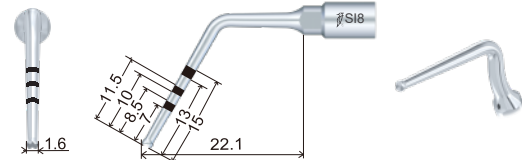

29

Implantation

Model

Unit: mm

Page

SI9

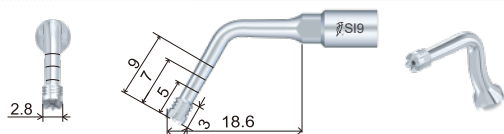

29

Periodontal surgery

Model

Unit: mm

Page

SP1

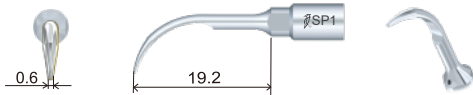

30

SP2

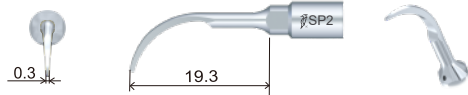

30

SP3

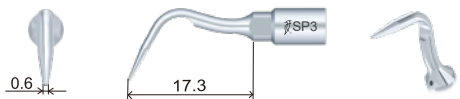

31

Periodontal surgery

Model

Unit: mm

Page

SP4

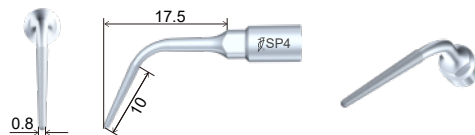

31

SP5

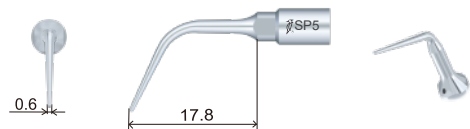

32

SP6

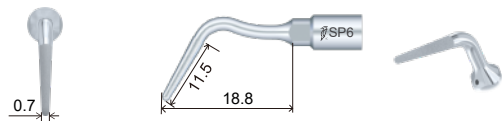

32

SP7

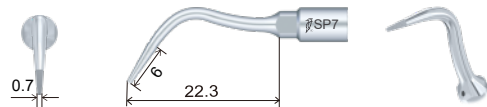

33

SP8

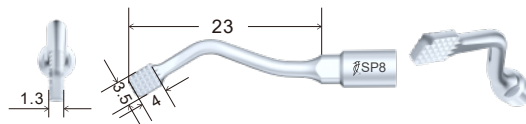

33

Periodontal surgery

Model

Unit: mm

Page

SP9

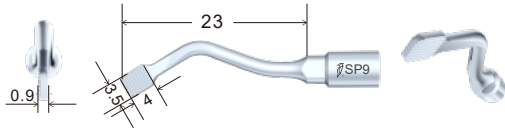

34

**SPOILING YOU
SO MUCH!**



SS1

Efficient osteotomy for larger bone sections in maxillofacial surgery and also for incisional extraction of wisdom teeth.

Ultrasonography Tips

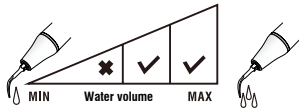

Water volume:

The first grid indicates the water volume: 0-30%

The second grid indicates the water volume: 30%-60%

The third grid indicates the water volume: 60%-100%

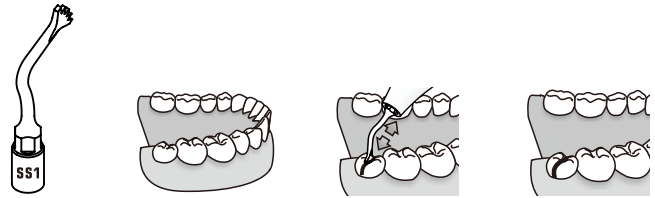

Model: Bone



SS1L

Left angle 90°, osteotomy on the maxilla and mandible.

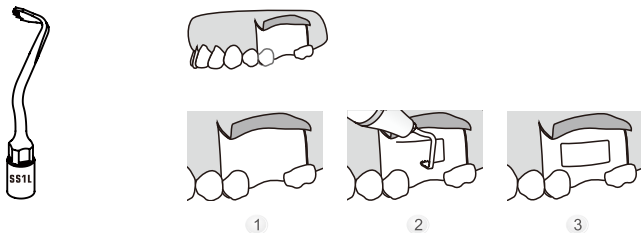

SS1R

Right angle 90°, osteotomy on the maxilla and mandible.

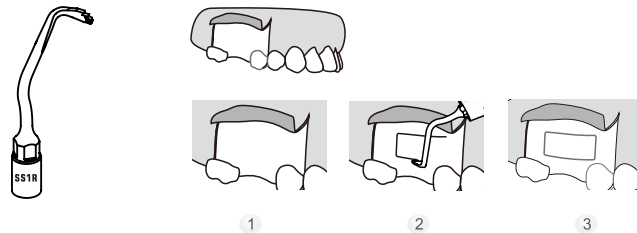

Model: Bone

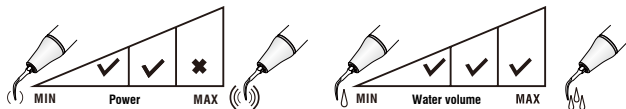

Model: Bone



SS2

High-effectiveness osteotomy on the maxilla and mandible (ridge expansion, corticotomy, bone grafting).

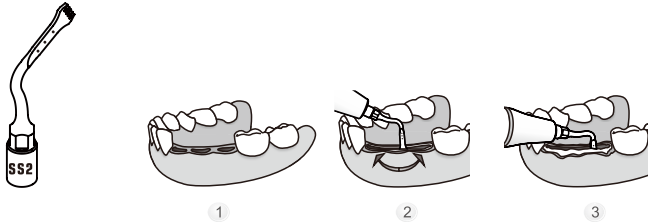

SS3

Osteotomy: Osteotomy of high precision in anatomically thin structures.

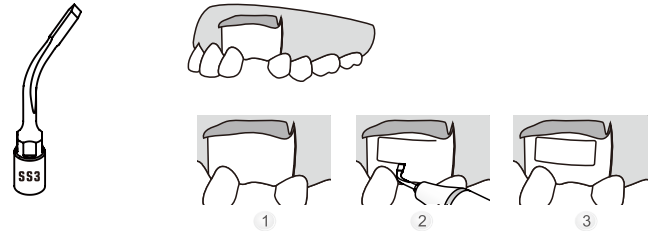

Model: Bone



Model: Bone



SS4

Universal osteoplasty: periodontal osteotomy, harvesting of bone particles or chips, inflammatory tissue removal.

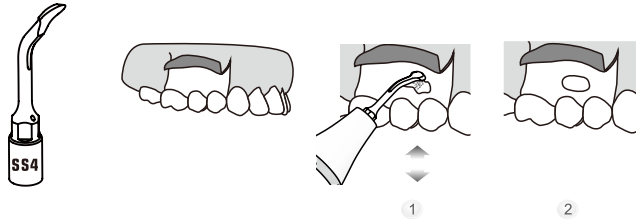

SS5

High-efficiency osteoplasty: for bone remodeling or harvesting of bone particles or chips.

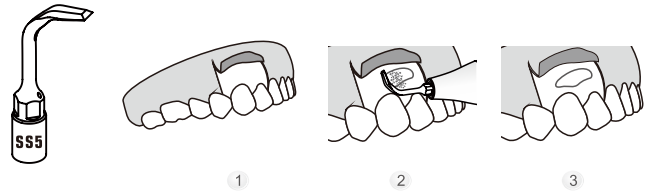

Model: Bone

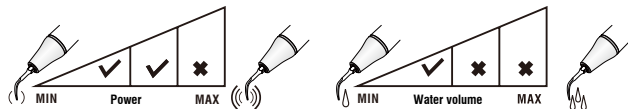

Model: Bone



SS6

Osteotomy: Osteotomy of high precision in anatomically thin structures (ridge expansion, corticotomy).

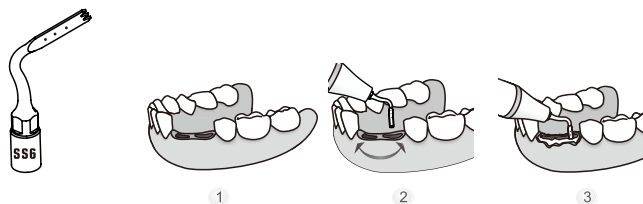

SS8

Multi-faceted distribution of blade teeth, suitable for various osteotomies.

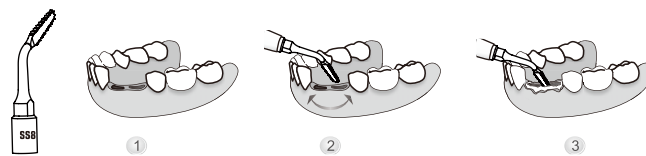

Model: Bone



Model: Bone

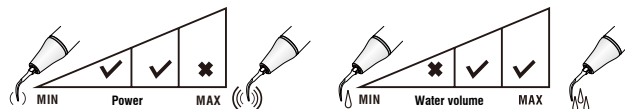

SS9

Multi-faceted distribution of blade teeth, suitable for various osteotomies.

SS11L

Left angle 90°, circumferential teeth, for osteotomy in special bone positions.

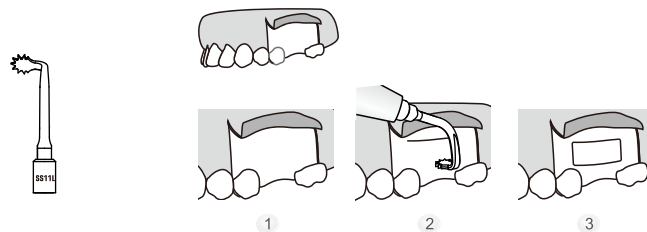
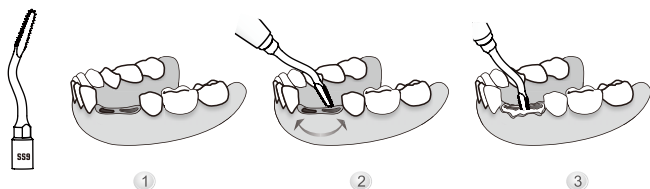

Model: Bone

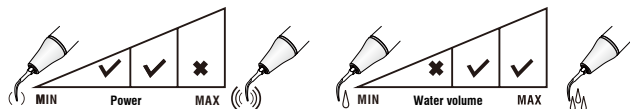

Model: Bone

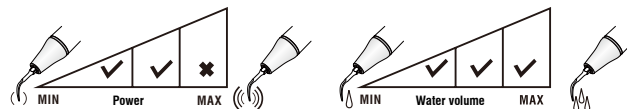

SS11R

Right angle 90°, circumferential teeth, for osteotomy in special bone positions.

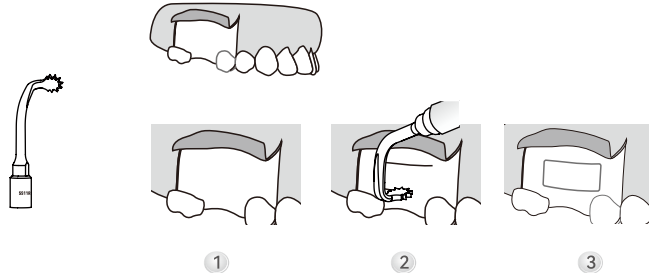

Model: Bone

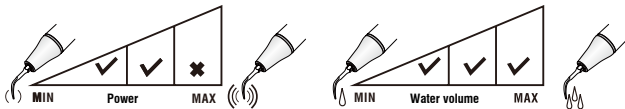

SS13

For osteotomy and also for apex resection in the posterior tooth area in apical surgery.

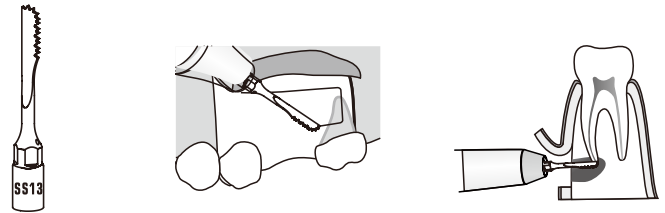

Model: Bone

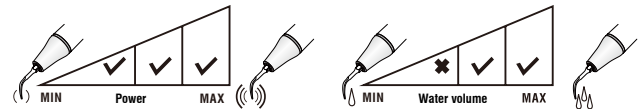

SS18

Extremely thin, for efficient osteotomy and also for apex resection.

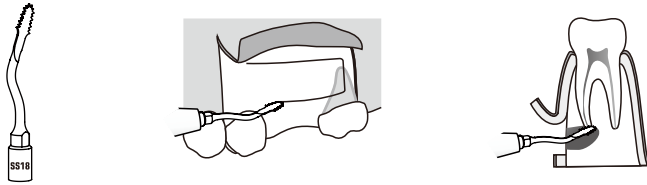

SS21

For osteotomy. Fan-shaped serration, convenient for multi-angle cutting.

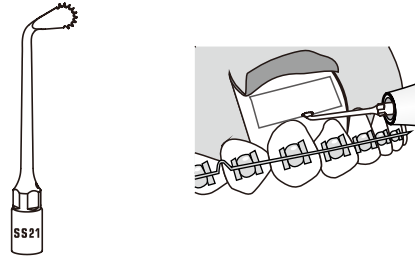

Model: Bone



Model: Bone



SS25

For bone surgery.

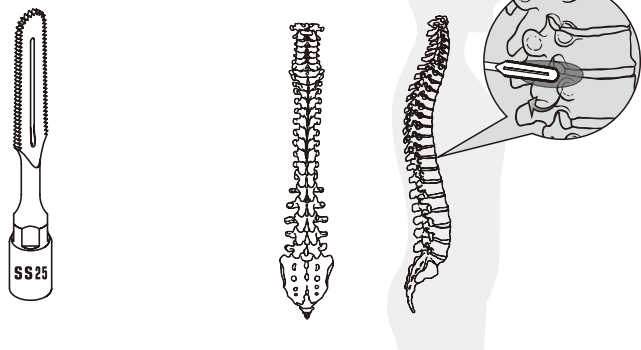

Model: Bone

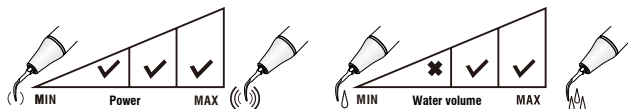

SS30

Extremely thin, for cutting trajectory positioning and bone cutting in bone splitting technique.

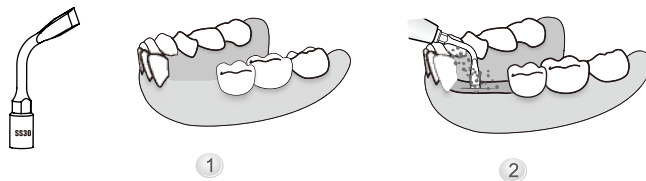

Model: Bone

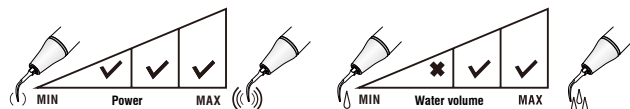

SS31

Recutting on the bone cutting track in bone splitting technique, used after SS30.

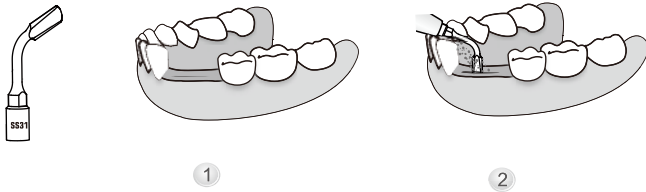

SS32

For bone expansion in bone splitting technique. Conical sharp tip head, 1.8mm thickness at the front 8mm part.

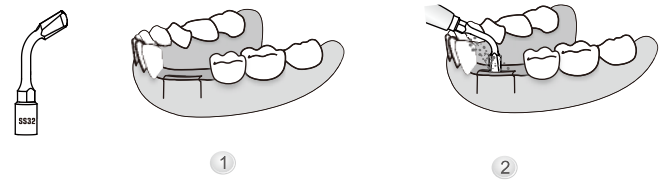

Model: Bone



Model: Bone



SS33

For bone expansion in bone splitting technique. Conical sharp tip head, 2.75 thickness at the front 8mm part.

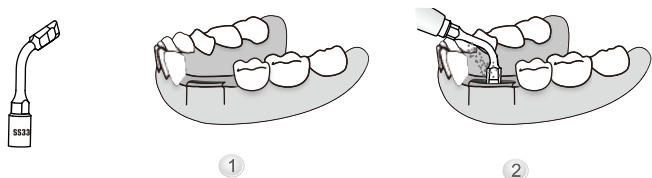

Model: Bone



SS34

For bone expansion in bone splitting technique. Conical sharp tip head, 3.75 thickness at the front 8mm part.

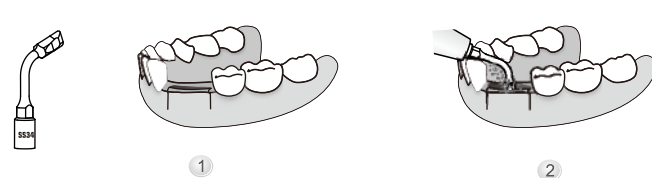

Model: Bone



SL1

Tip angle 120°. For maxillary sinus membrane detachment and elevation without damaging the maxillary sinus mucosa.

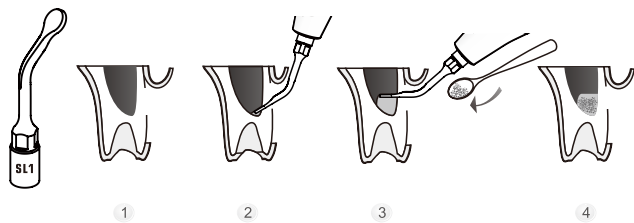

SL2

For nasal mucosa separation: detachment of the maxillary sinus mucosa.

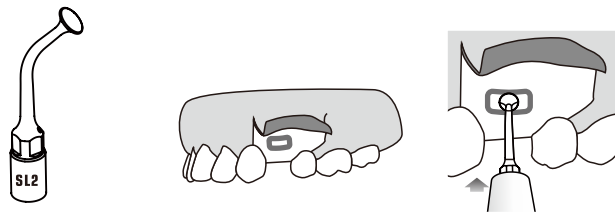

Model: Perio

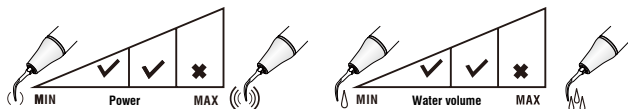

Model: Perio

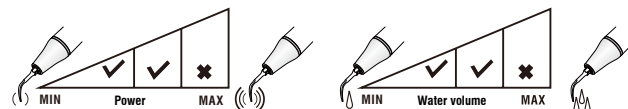

SL3

Diamond-coated (100 μ m) tip for fine osteotomy or osteoplasty: for non-traumatic osteotomy close to soft tissue and sensitive areas.

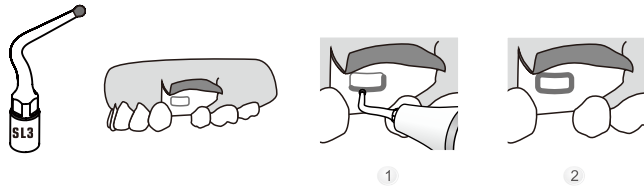

SL4

Diamond-coated (100 μ m) tip for fine osteotomy: for cutting of extremely-thin bone, to avoid soft tissue damage (nasal mucosa, vessel, alveolar nerve).

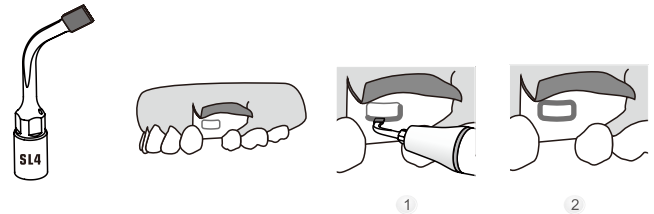

Model: Bone



Model: Bone

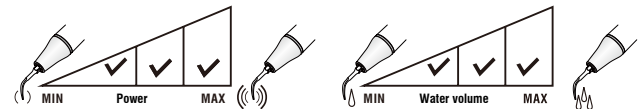

SL5

Tip angle 95°. For maxillary sinus membrane detachment and elevation without damaging the maxillary sinus mucosa.

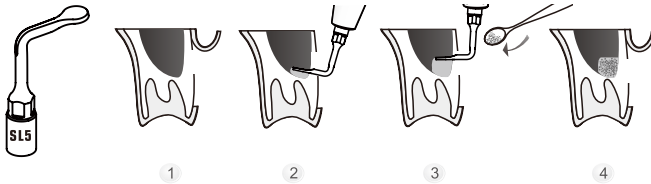

SL6

Φ3mm head with four water outlets, for better separation of the maxillary sinus periosteum. The diamond-coated portion allows for trimming of the edges of the bone window.

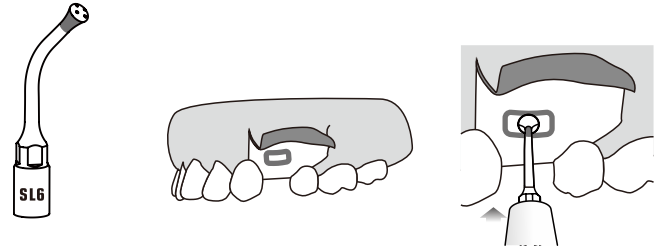

Model: Perio



Model: Perio

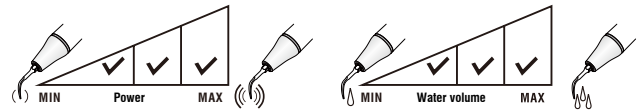

SL7

Φ4.5mm head with four water outlets, for better separation of the maxillary sinus periosteum. The diamond-coated portion allows for trimming of the edges of the bone window.

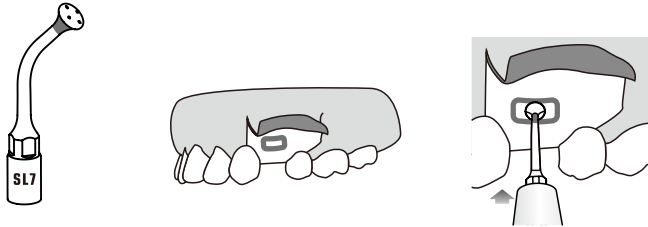

SL8

Diamond-coated (100µm) tip for fine osteotomy or osteoplasty: for non-traumatic osteotomy close to soft tissue and sensitive areas.

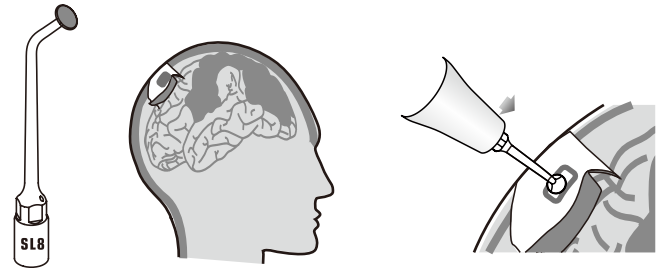

Model: Perio

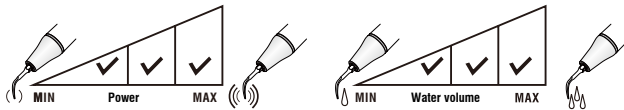

Model: Perio

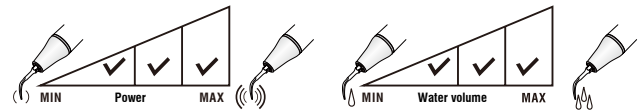

SL13

Diamond-coated, for osteoplasty and bone trimming in the interproximal area, often used in crown lengthening.

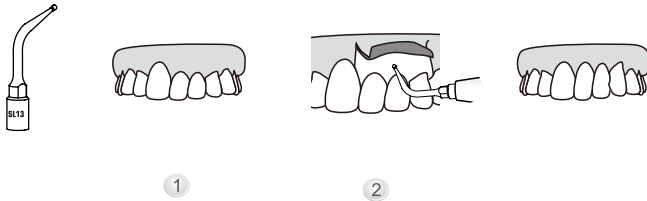

Model: Bone

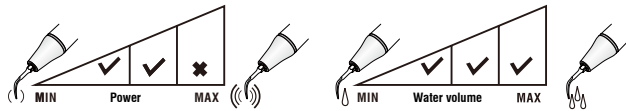

SL14

Diamond-coated, for osteoplasty and bone trimming in the interproximal area, often used in crown lengthening.

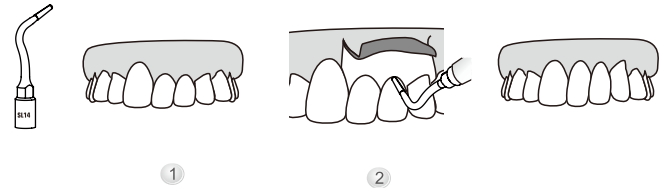

Model: Bone



SE1

Diamond-coated (40µm) tip for apical debridement: for high-efficiency root-end preparation and apical surgery. Diamond-coated part is 3.3mm in length.

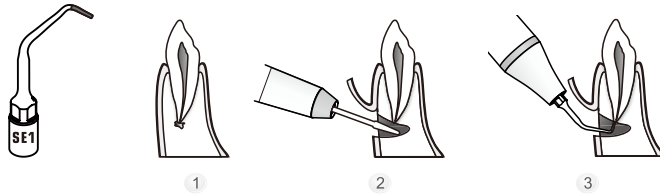

SE2

Polishing the canal wall in apical debridement. The tip smooth part is 4.5 mm in length.

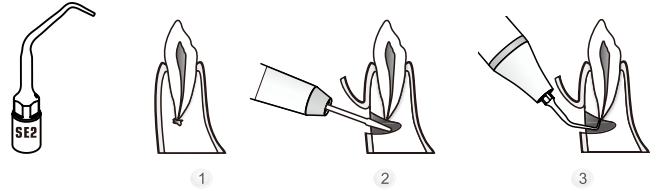

Model: Endo

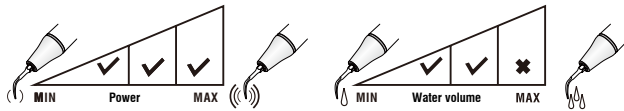

Model: Endo



SE3

Diamond-coated (40µm) tip for apical debridement: for high-efficiency root-end preparation and apical surgery. Diamond-coated part is 2.2mm in length.

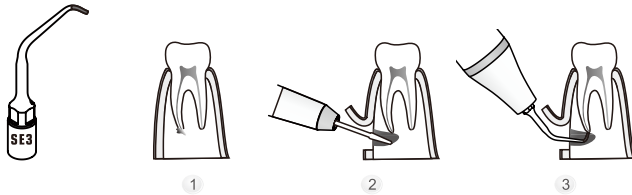

SE4

Polishing the canal wall in apical debridement. The tip smooth part is 3.5 mm in length.

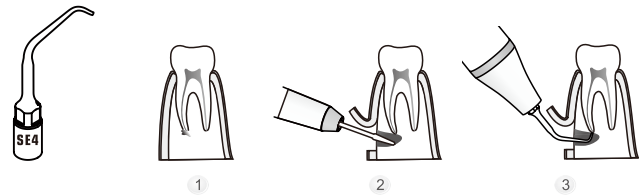

Model: Endo

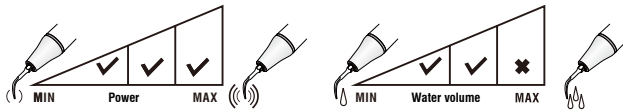

Model: Endo

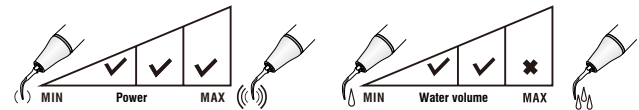

SE5

Diamond-coated, for root-end preparation.

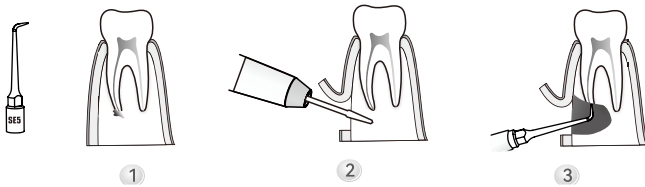

SE6

Diamond-coated, for root-end preparation.

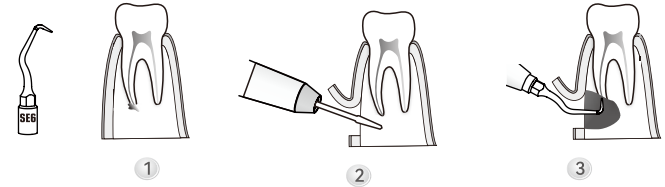

Model: Endo

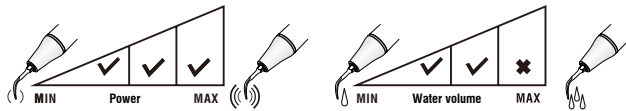

Model: Endo

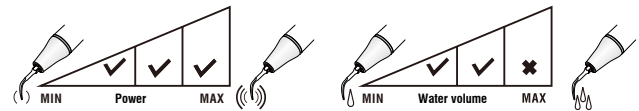

SE7

Diamond-coated, for root-end preparation.

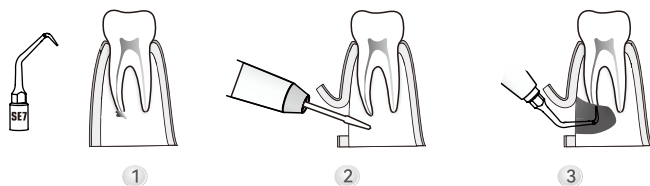

SE8

Diamond-coated, for root-end preparation.

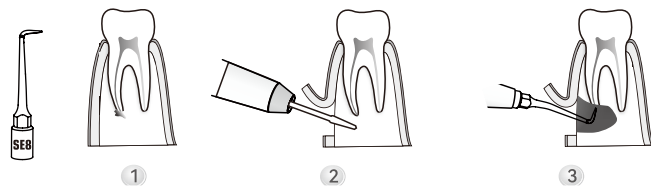

Model: Endo

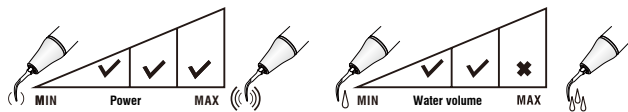

Model: Endo

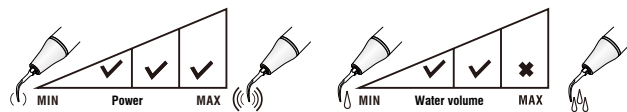

SE9

Right-angled and diamond-coated tip, for root-end preparation.

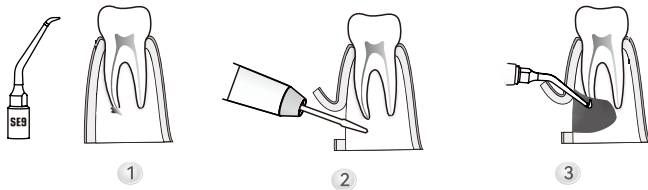

SC1

For minimally invasive removal of ligaments and root surgery.

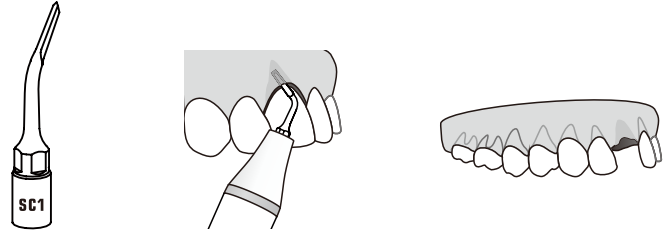

Model: Endo

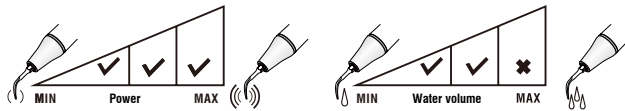

Model: Bone

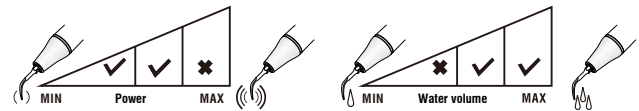

SC2

Left-curved, for minimally invasive removal of ligaments and root surgery in posterior regions.

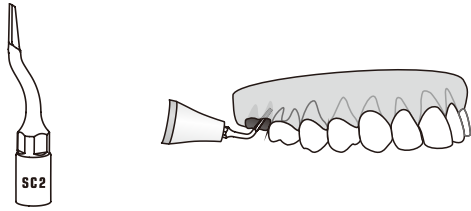

SC3

Right-curved, for minimally invasive removal of ligaments and root surgery in posterior regions.

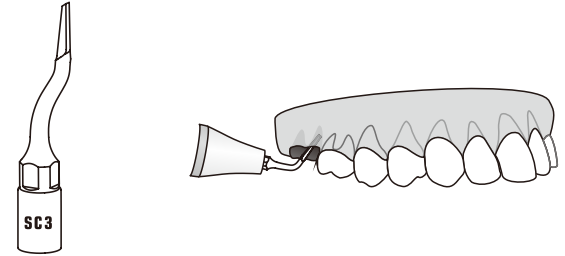

Model: Bone

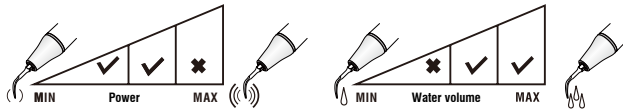

Model: Bone

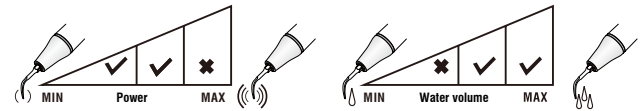

SC4

For distal ligament cutting, minimally invasive extraction.

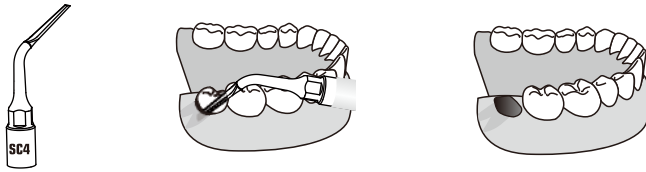

SC5

For minimally invasive cutting of ligaments and gap increase in tooth extraction, especially suitable for the extraction of wisdom teeth with an oblique angle.

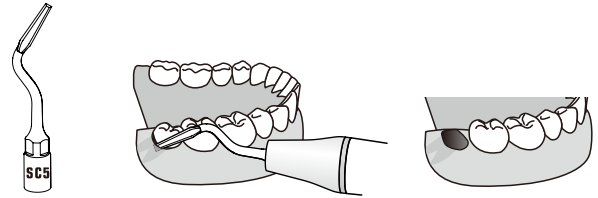

Model: Bone



Model: Bone



SC6

For tooth extraction and alveolar bone splitting.

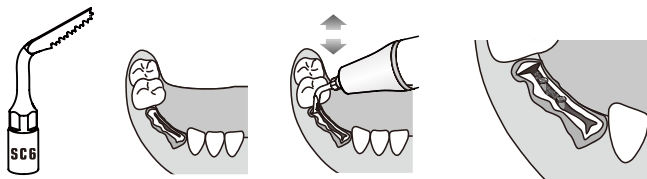

SC7

For tooth extraction and alveolar bone splitting.

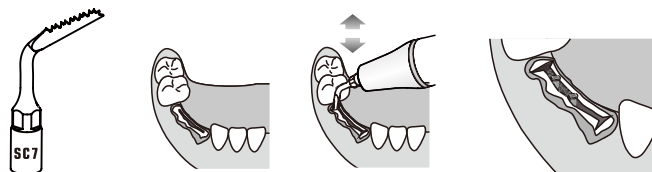

Model: Bone



Model: Bone



SC8

For minimally invasive cutting of ligaments and gap increase in tooth extraction, with a very sharp and pointed tip extremity.

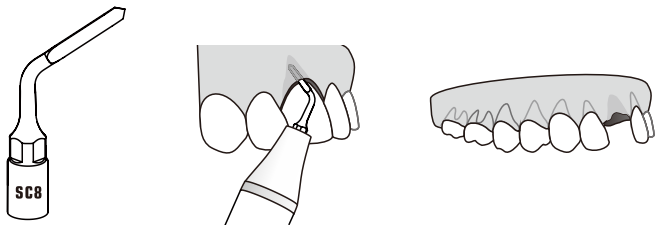

SI1

For implant preparation, with $\Phi 1.6\text{mm}$ head and 9mm tip working length.

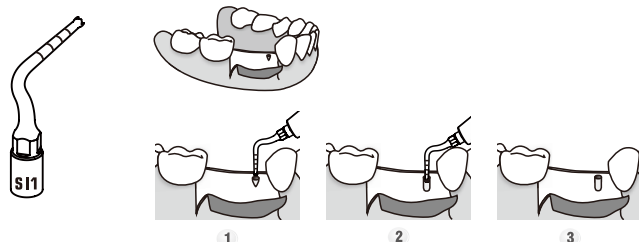

Model: Bone

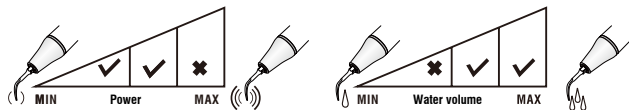

Model: Bone



SI2

For implant preparation, with $\Phi 2\text{mm}$ head. There is water out from the tip center to avoid overheating.

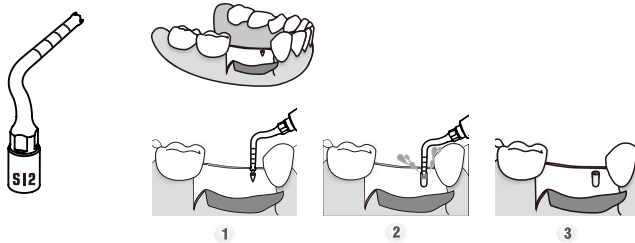

SI3

$\Phi 2\text{mm}$ implant preparation tip used in the anterior regions, with sharp tip extremity and water out from the center.

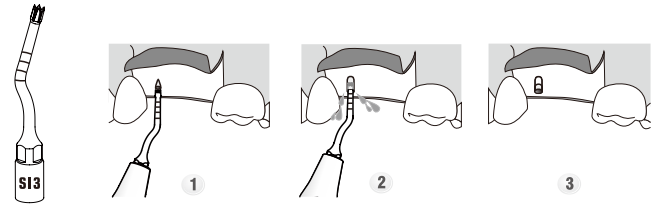

Model: Bone



Model: Bone



S14

Φ3mm implant preparation tip used in the anterior regions, with sharp tip extremity and water out from the center.

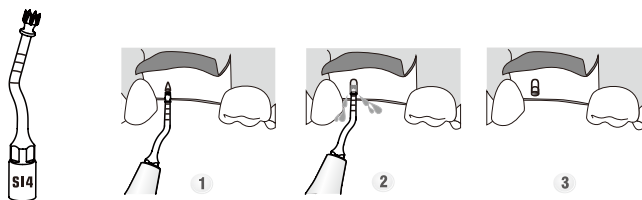

S15

Φ2mm implant preparation tip used in the posterior regions, with sharp tip extremity and water out from the center.

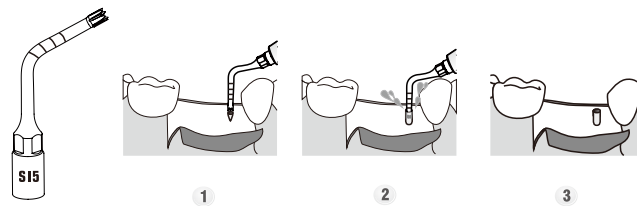

Model: Bone



Model: Bone



S16

Φ3mm implant preparation tip used in the posterior regions, with sharp tip extremity and water out from the center.

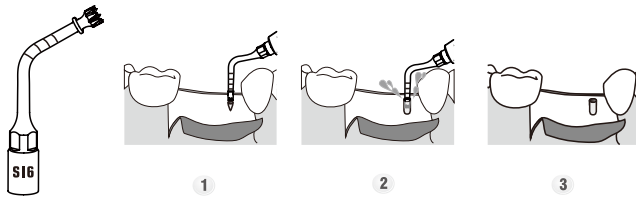

S17

Diamond-coated (85µm), for finalizing implant site bone preparation close to the alveolar nerve.

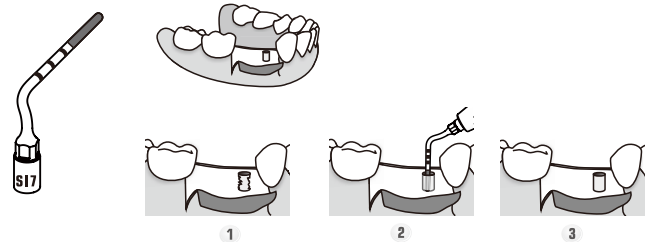

Model: Bone

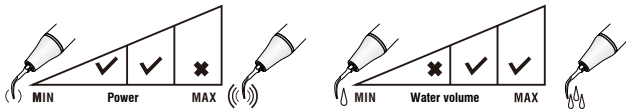

Model: Bone



SI8

For implant preparation, with $\Phi 1.6\text{mm}$ head and 9mm tip working length.

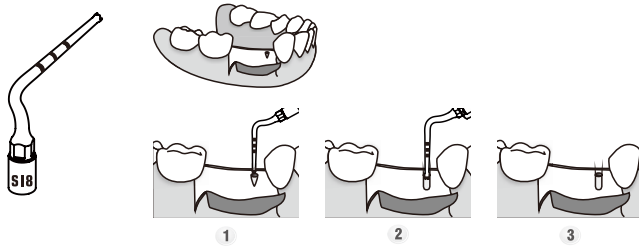

SI9

For implant preparation, with $\Phi 2.8\text{mm}$ head. There is water out from the tip center to avoid overheating.

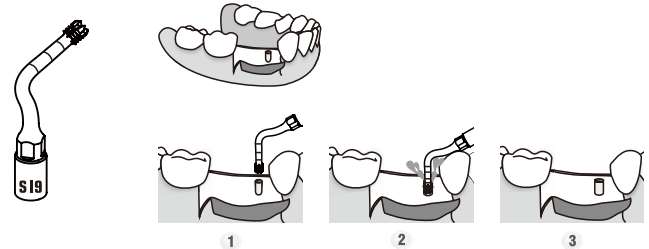

Model: Bone

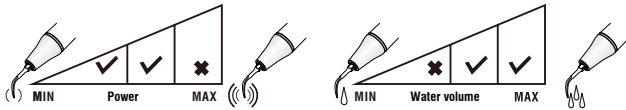

Model: Bone

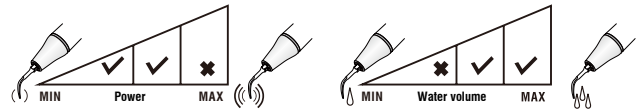

SP1

For gentle scaling in periodontal surgery.

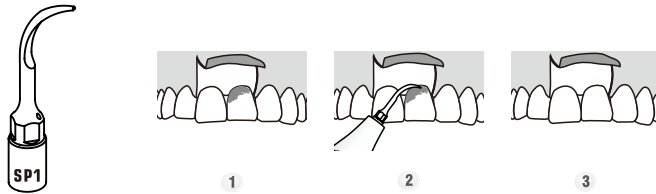

SP2

For fractured root apex extraction and inflammatory tissue removal.

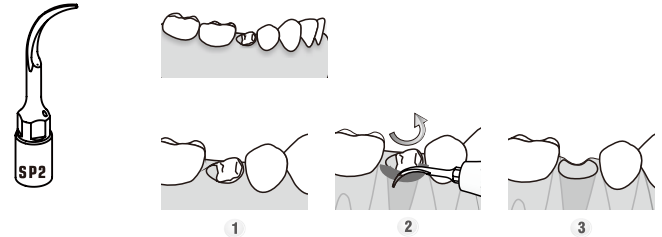

Model: Perio

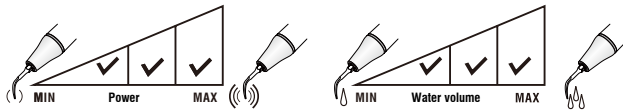

Model: Perio



SP3

For multi-angled gentle scaling in periodontal surgery.

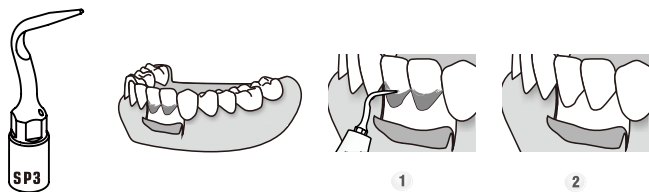

SP4

Diamond-coated (40µm), for apical debridement and root planning.

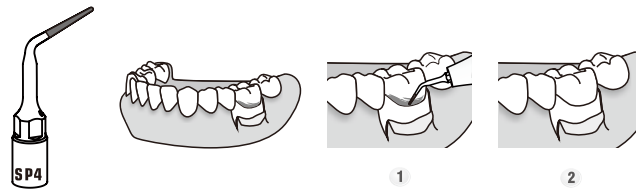

Model: Perio

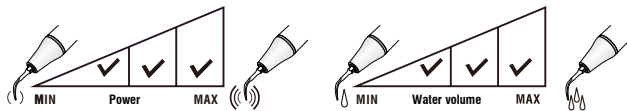

Model: Perio

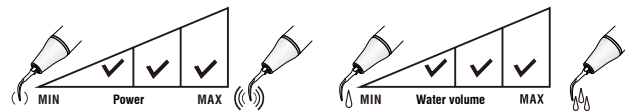

SP5

For fine root planning.

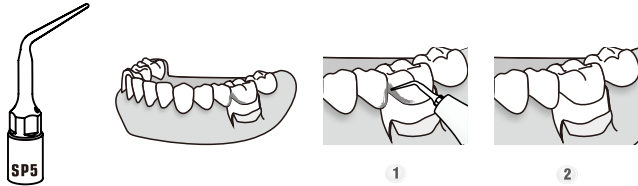

SP6

Diamond-coated (40µm) tip for fine osteoplasty: interproximal osteoplasty and root planning.

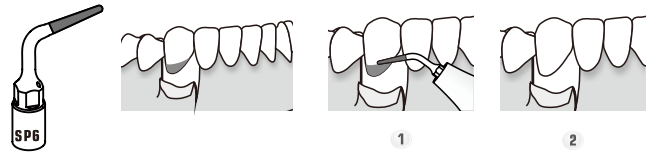

Model: Perio



Model: Perio

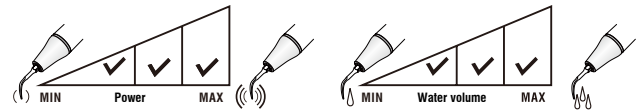

SP7

Diamond-coated (40µm), for root canal locating and removal of calcifications in the coronal 1/3 part of root canal, and can also be used for fine osteoplasty.

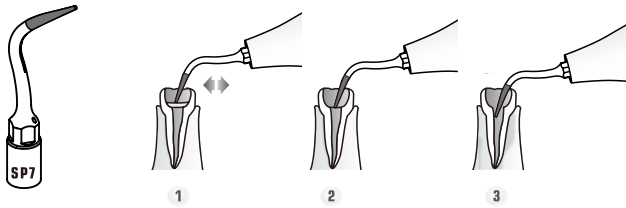

SP8

Coarse mesh-shaped concave-convex surfaces on both sides of the head, for osteoplasty and bone trimming.

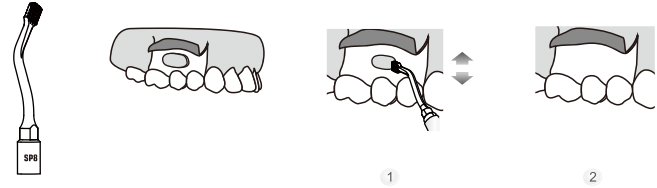

Model: Perio



Model: Perio

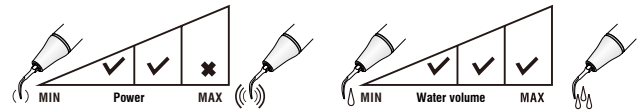

SP9

Coarse mesh-shaped concave-convex surfaces on both sides of the head, for osteoplasty and bone trimming.

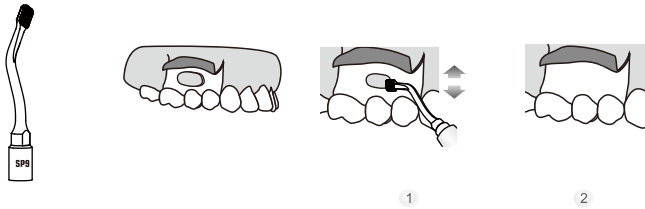

Model: Perio

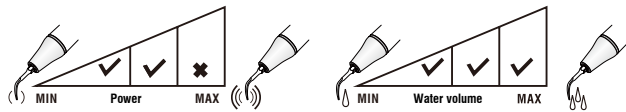



Guilin Woodpecker Medical Instrument Co., Ltd.
Information Industrial Park, Guilin National High-Tech
Zone, Guilin, Guangxi, 541004 P. R. China

Tel:

Europe Sales Dept.: +86-773-5873196

North/South America & Oceania Sales Dep.: +86-773-5873198

Asia & Africa Sales Dep.: +86-773-5855350 Fax: +86-773-5822450

E-mail: woodpecker@glwoodpecker.com, sales@glwoodpecker.com

Website: <http://www.glwoodpecker.com>



MedNet EC-Rep GmbH
Borkstrasse 10 · 48163 Muenster · Germany

ZMN-XC-092 V1.0-20220719

