



...is all you need

HXA20

HXA30

HXA40

HXA45

HXA65

HXA85

HXA1K

HXA2K

HXA3K

HXA4K

HXA5K



HXA HIGH POWER AMPLIFIER SERIES

CONGRATULATIONS !

You now own an EXCURSION HXA High Power Series Amplifier, the product of an uncompromising design and german engineering philosophy. A product made from Car Audio fanatics who truly believe in the relentless pursuit of perfection.

EXCURSION amplifiers are the result of several decades of product improvements, competition, innovation and highest quality parts and control standards in industry. When properly installed these amplifiers will provide you with many years of listening pleasure and are the perfect balance between high fidelity, extreme performance and long-lasting reliability.

Should your amplifier ever need a service, Please record your information on the following lines to refer to in the event that you may need it later.

Dealer's Name _____

Date of Purchase _____

Installation Shop _____

Installation Date _____

At EXCURSION Intl. we are confident you will have many years of outstanding enjoyment from your high performance investment. For maximum performance we recommend that you have your new EXCURSION HXA Amplifier installed by an exclusive Authorized EXCURSION Dealer

To learn more about EXCURSION, please visit us on the World Wide Web at

<http://www.excursion.us>

CAUTION !

Continuous exposure to sound pressure levels in excess of 100dB can cause permanent hearing loss. EXCURSION Products are capable of producing sound pressure levels well over 170dB. Please observe all local sound ordinances while listening to your EXCURSION System. EXCURSION Intl. accepts no liability for hearing loss, bodily injury, or property damage due to the result of use or misuse of this product.

HXA SPECIFICATIONS

Model	HXA45	HXA65	HXA85	HXA20	HXA30	HXA40	HXA1K	HXA2K	HXA3K	HXA4K	HXA5K
Description	4 Channel			2 Channel			1 Channel (MONO)				
10hm Load @ 14.4V	NA			NA			NA	1200W	1800W	2400W	3000W
20hm Load @ 14.4V	4x 90W	4x125W	4x200W	2x125W	2x200W	2x700W	600W	800W	1200W	1600W	2000W
40hm Load @ 14.4V	4x 70W	4x100W	4x150W	2x100W	2x150W	2x500W	400W	400W	600W	800W	1000W
40hm Load @ 14.4V	2x180W	2x250W	2x400W	1x250W	2x400W	1x1100W	NA				
40hm BRIDGE 2 AMPS	NA			NA			1200W	1600W	2400W	3200W	4000W
20hm BRIDGE 2 AMPS	NA			NA			NA	2400W	3600W	4800W	6000W
FEATURES											
Input Sensitivity	0.2 ~ 5.0 V Low Level (PRE)										
Auto Turn ON/OFF	0.6 ~ 15.0 V High Level (SPK)										
Frequency Response	DC (Headunit) or AUDIO (amplified music impuls)										
Low Pass Filter	15 ~ 25KHz										
HPF or BPF Subsonic	Front 0 ~ 300Hz		Rear 0 ~ 80Hz		0 ~ 300Hz		5 ~ 300Hz				
Bass Boost	NA										
Optional Remote	NA										
Minimum Load	20hm		20hm		20hm		10hm		0.50hm		
S/N Ratio	> 80%		> 80%		> 80%		> 100%				
THD @ 40hm Load	< 0.05%		< 0.3%		< 0.3%		> 80%				
Efficiency @ 40hm	> 80%										
Low Voltage Protection	YES < 8Volt										
Overheat Protection	Protect @ 80° / 176F										
Short Circuit Protection	YES - Test PASS										
Components & PCB	military standard / SMD parts / double side FR-4 PCB										
ext. Fuse Requirement	40A	60A	100A	30A	50A	150A	60A	100A	150A	200A	250A
Power Terminal +/-	Screw	4GA	Screw	Screw	4GA	Screw	Screw	4GA	4GA	0GA	0GA
Speaker Terminals	Screw	8GA	Screw	Screw	8GA	Screw	Screw	8GA	8GA	8GA	8GA
DIMENSION											
Height	54 mm										
Width	140 mm										
Length (Heatsink) mm	240	280	355	200	240	405	200	280	355	405	530

FRONT PANEL LAYOUT

Fig 1. 4-ch amplifier panel layout

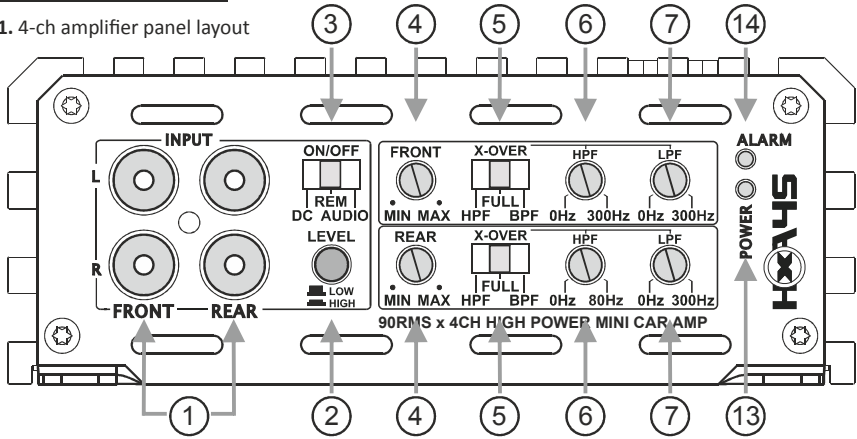

Fig 2. 2-ch amplifier panel layout

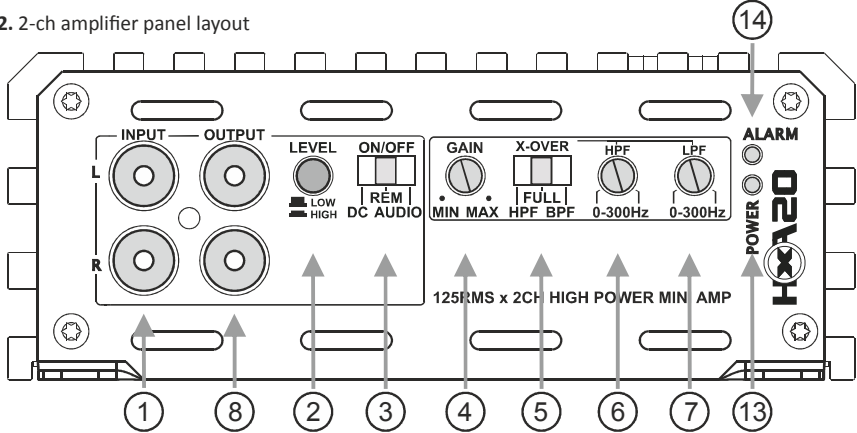
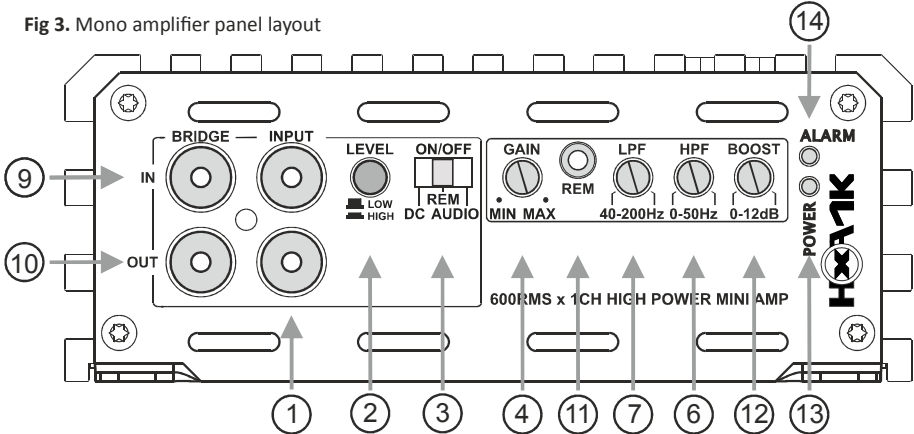

Fig 3. Mono amplifier panel layout



REAR PANEL LAYOUT

Fig 1. 4-ch amplifier panel layout

(HXA65 / HXA 85 - 8GA SPK and 4GA POWER allen screw Terminal)

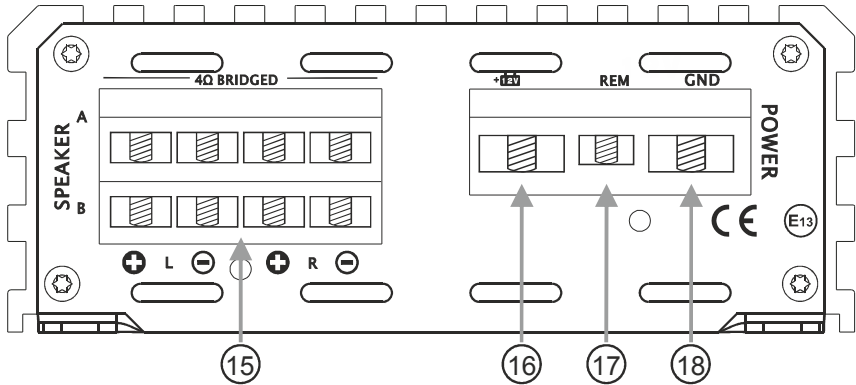

Fig 2. 2-ch amplifier panel layout

(HXA30 / HXA 40 - 8GA SPK and 4GA POWER allen screw Terminal)

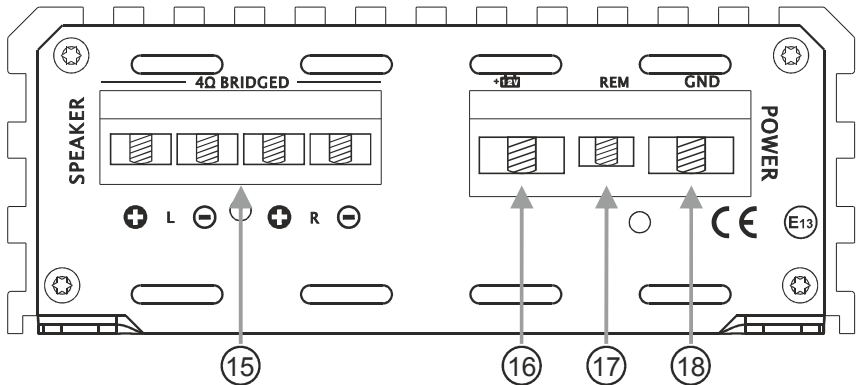
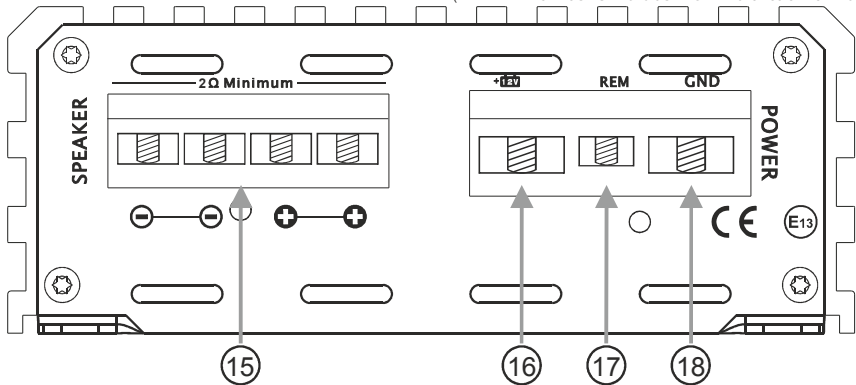

Fig 3. Mono amplifier panel layout

(HXA2K / HXA3K - 8GA SPK and 4GA POWER allen screw Terminal)

(HXA4K / HXA5K - 8GA SPK and 0GA POWER allen screw Terminal)



CONTROL FUNCTIONS

1. RCA Audio Input

These RCA Input jacks connect with your source unit RCA Low Level Outputs or via optional Adapter (XML/XFM) with your source unit Speaker High Level Outputs. The use of high quality twisted pair car audio cables is recommended to mind possibility of disturbance the audio signal.

2. Input Mode Switch

This Switch select the operating Signal input Voltage of your Excursion HXA Amplifier

- 2.1 Low Level Signal (RCA Output Headunit) operate Input within a range of 0.2 - 5.0V.
- 2.2 High Level Signal (Speaker Out Headunit) operate Input within a range of 0.5 - 15V.

3. TURN ON/OFF Mode Switch

This Switch select between 3 Options to Turn ON/OFF your Excursion HXA Amplifier

- 3.1 Automatic via DC provided at RCA Input via SPEAKER High Level Input from Headunit.
- 3.2 Switched via (+)12V REM Signal is provided and connected with REM Terminal (see 17).
- 3.3 Automatic via music signal impuls provided at RCA Input (Turn ON/OFF time delayed)

4. GAIN Control

The Gain controle will match the amplifiers sensitivity to the provided source unit signal voltage.

5. X-Over Mode Switch

This Switch select between 3 Options of operating frequency range of your Excursion Amplifier

- 5.1 HPF - High Pass filter the unwanted low frequency range from your audio signal.
- 5.2 FULL - Fullrange setting route your audio signal without any Filter direct to amplification.
- 5.3 BPF - operating High Pass and Low Pass filter high and low FQ from your audio signal.

6. HIGH PASS FILTER Control

This knob controls the frequency x-over point from where Low Frequency can be cut out.

7. LOW PASS FILTER Control

This knob controls the frequency x-over point from where High Frequency can be cut out.

8. RCA Audio Output

These RCA Audio Output Jacks offer the possibility to route the audio signal to further Amplifier. Welcome for example if Headunit offer only one Output and an additional HXA Mono Amplifier with external REMOTE Controle need to share same signal. Function is to compare with Y-RCA Adapter.

9. BRIDGE IN

This RCA jack receives signal from the master amplifier when this amplifier is bridged as slave.

DO NOT USE RCA AUDIO INPUT jacks (see 1) when the amplifier is working as slave. All functions will be adjusted by the master amplifier. Please see the drawing of bridging at page 12.

10. BRIDGE OUT

This RCA output send out bridge signal to another same HXA Amplifier in bridging configuration. All functions will be adjusted by the master amplifier. Please see the drawing of bridging at page 12.

11. REMOTE - Bass Level Control (Optional)

The Volume of your HXA Mono Amplifier can get adjusted via remote controle from driver seat.

12. BASS BOOST

This knob adjust the 45Hz signal boost level from 0 up to 12dB. Preferable for small size cars.

CONTROL FUNCTIONS

13. POWER Indicator

This LED will light up when amplifier works properly. It will flash or shut down once amplifier in self-testing or malfunction.

14. ALARM Indicator

This LED will light up if amplifier has detected a fault or has shut down to protect itself. This may be caused - for example - at excessive heat, reverse polarity, short circuit or overload. In this case please turn off the amplifier, disconnect and resolve the problem before continuing.

15. Speaker Terminals

Connect your speaker to these terminals with proper polarity. Never connect the speaker cables with chassis ground, effect short circuit and damage amplifier. Note: We have designed 8GA Terminals to fit Hollywood Energetic HPST Adapters = DUAL OUT

16. (+)12 Volt Battery Terminal

Connect this terminal with proper AWG size OFC Power Cable through a Fuse to the positive terminal of the car battery or the positive terminal of an isolated external car audio battery. WARNING: Always protect the Power Cable via Fuse less than 12inch (30cm) from battery terminal. WARNING: HXA Amplifiers need external Fuse not less than 12inch (30cm) from Power terminal. Please follow the maximum Fuse recommendation from Excursion HXA Specifications. See Page 2. Note: We have designed 4GA+0GA Terminals to fit Hollywood Energetic HPST Adapters = DUAL IN.

17. REM Terminal

This Remote terminal is to connect with headunit 12V remote output to turn ON/OFF the amplifier according to operating of headunit - if Turn ON/OFF Switch Option set on REM (see 3). If there are more amplifiers connected to this terminal it might be necessary, depending on REM performance of headunit, to install an additional relay. If amplifier turn ON/OFF Mode is set DC or AUDIO, then 12V Remote is not demanded, but REM terminal can provide and work as a 12V Remote Output distributor.

18. GND Terminal

This terminal is to connect directly to the frame of vehicle. Use shortest distance possible and equal or larger AWG OFC Cable size than +12Volt Battery Cable. Assure frame has been cleaned to bare metal.

INSTALLATION PRECAUTIONS

Before you install the amplifier, investigate your car's layout very carefully. Take special care when you work near the gas tank, fuel lines, hydraulic lines and electrical wiring. Before making or breaking power connections in your system, disconnect the car battery. Confirm that your headunit or other equipment is turned off while connecting the input jacks and speakers terminals. If you need to replace the power fuse, replace it only with a fuse identical to that suggested by this manual. Using a fuse of a different type or rating may result in damage to your system or your amplifier which is not covered by warranty.

CONNECTING THE AMPLIFIER

1. Connect the amplifiers ground cable to a close, bare metal part of the frame or chassis. Use a nut and bolt. The ground cable must be at least the same size as the +12Volt.
2. Connect the remote terminal to remote output of the head unit using upper 16GA wire if the remote turn ON/OFF Mode is set on REM.
3. Connect the fuse holder within 15" (30cm) of the car battery and run the selected cable from this fuse to the amplifier via additional fuse within max. 15" (30cm) distance to the amplifier.
4. Connect all the inputs with high quality car audio cables to assure the performance of your amplifier.
5. Connect Remote Control if necessary
6. Insert fuse(s) into the battery fuse holder(s).

WIRING DIAGRAM

Fig 1. HXA 45 / HXA 65 / HXA 85 wiring
(4 Channel Mode)

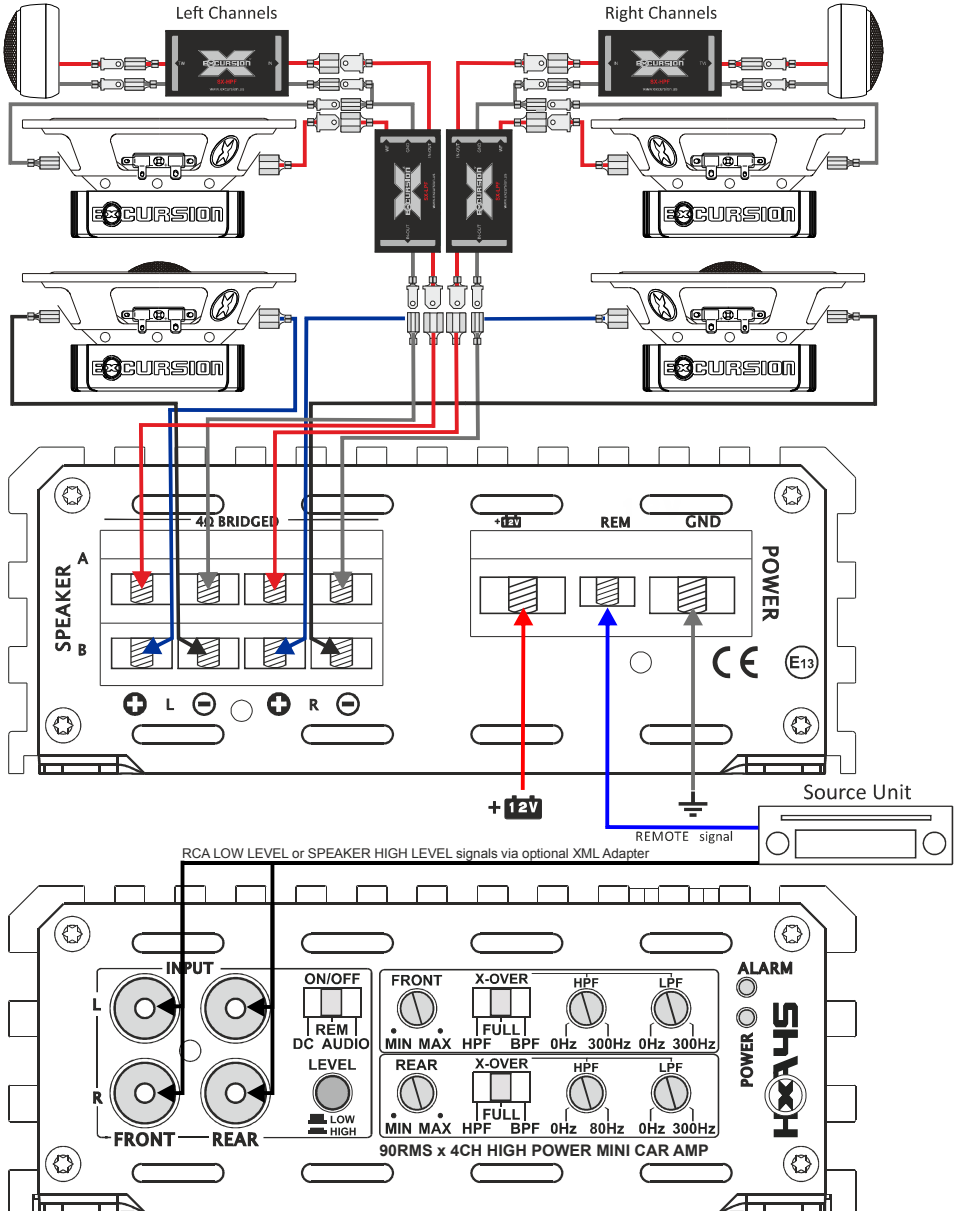

WIRING DIAGRAM

Fig 2. HXA 45 / HXA 65 / HXA 85 wiring
(3 Channel Mode)

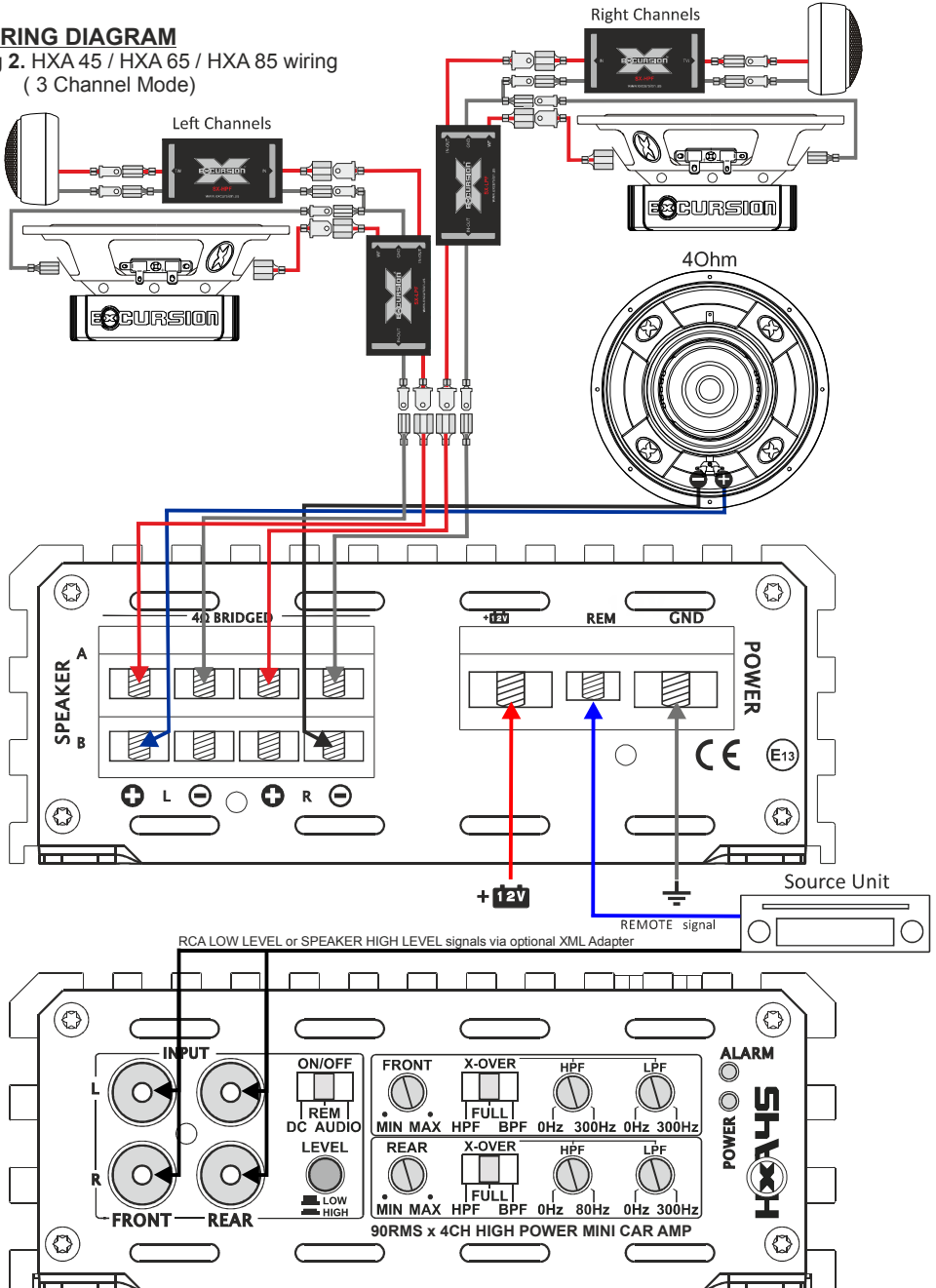

WIRING DIAGRAM

Fig 3. HXA 20 / HXA 30 / HXA 40 wiring
(2 Channel Mode)

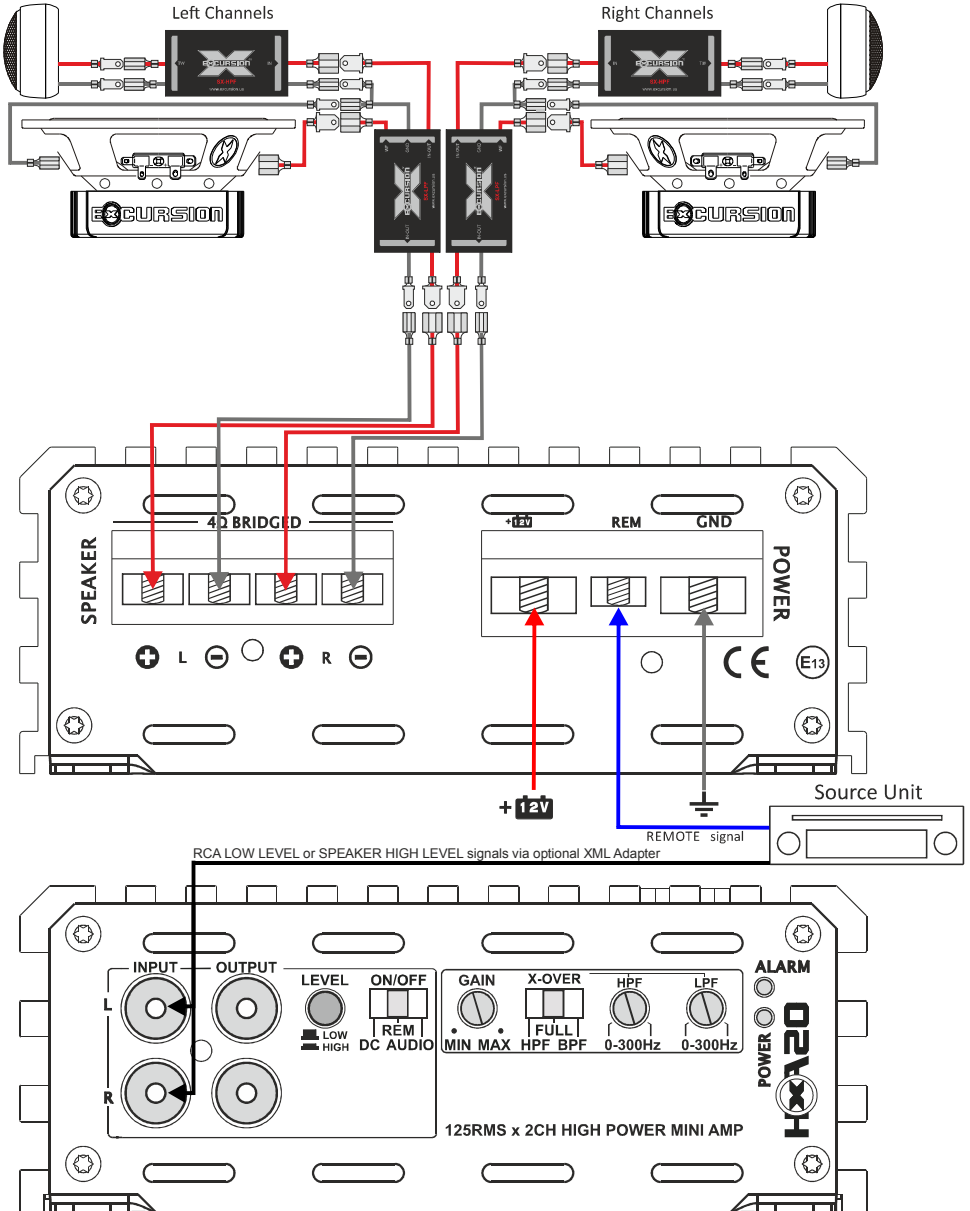

WIRING DIAGRAM

Fig 4. HXA 20 / HXA 30 / HXA 40 wiring
(1 Channel Mode)

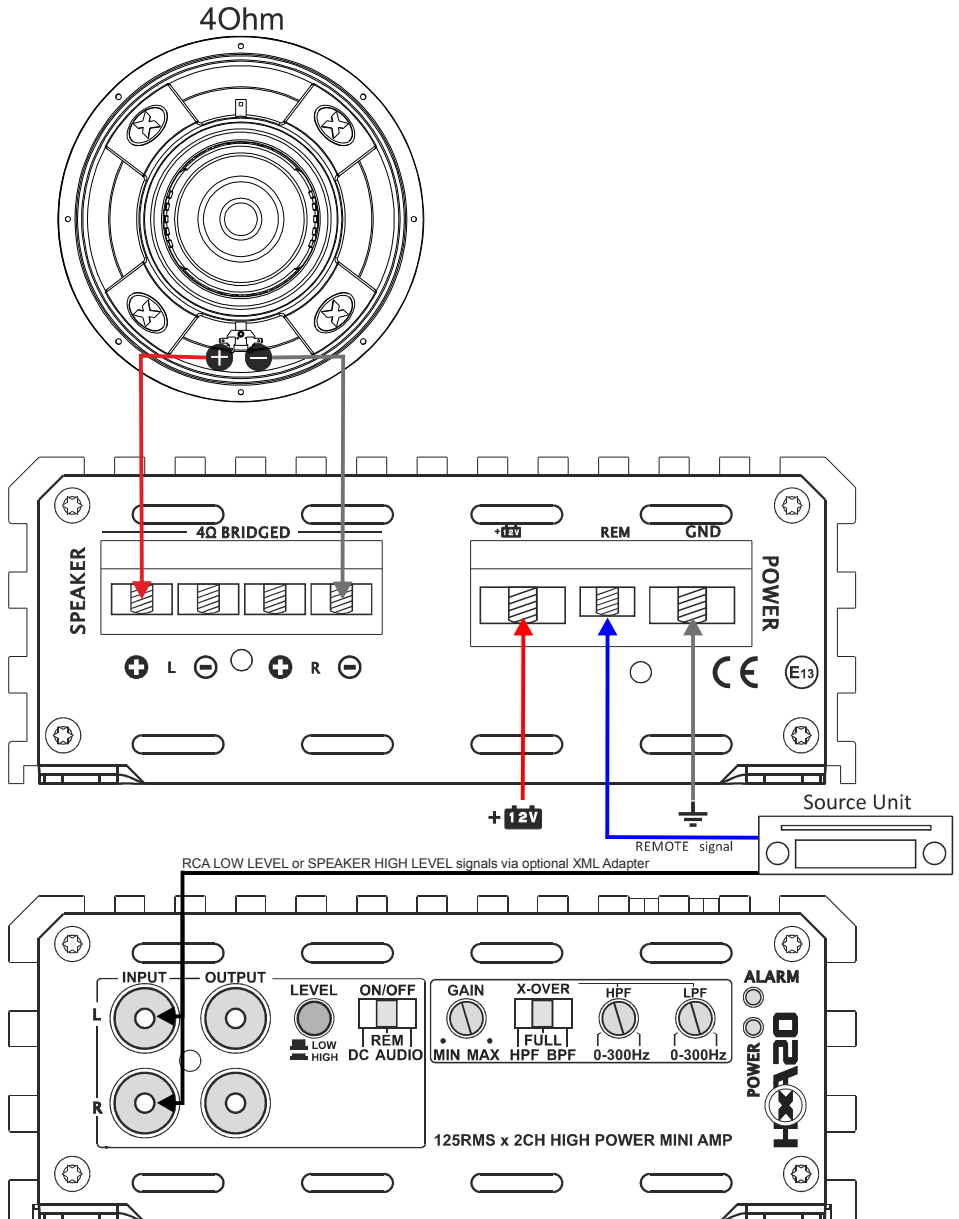

WIRING DIAGRAM

Fig 5. HXA 1K / HXA 2K / HXA 3K / HXA 4K / HXA 5K wiring
(1 Channel Mode)

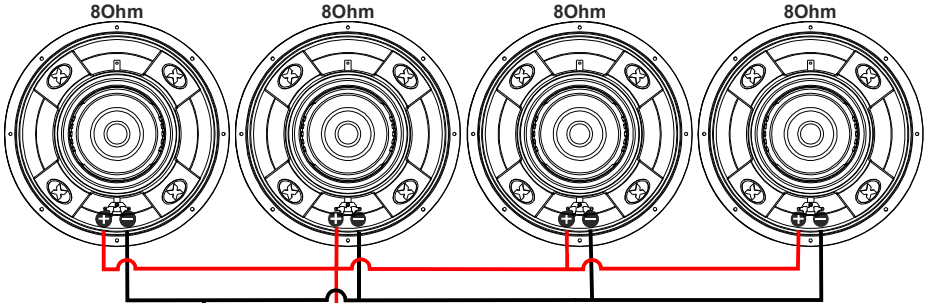

* Equivalent impedance load can not be less according minimum load of the individual HXA Mono Amplifier model. (2/1/0,50hm)
* Mono Amplifier provide Dual +/- Terminals. (they are connected parallel inside amplifier)

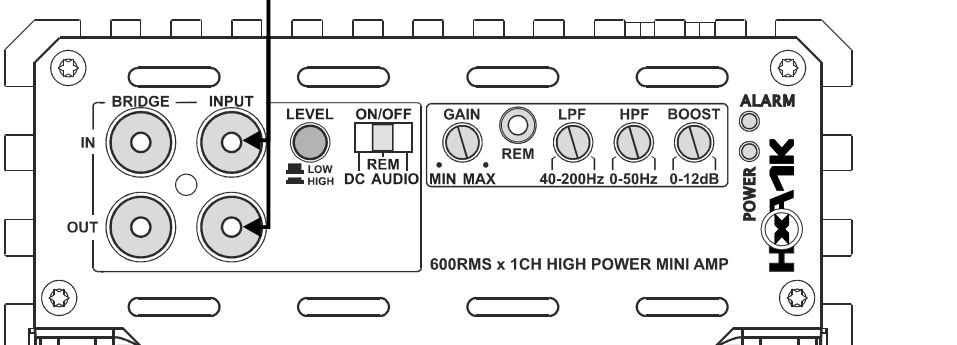
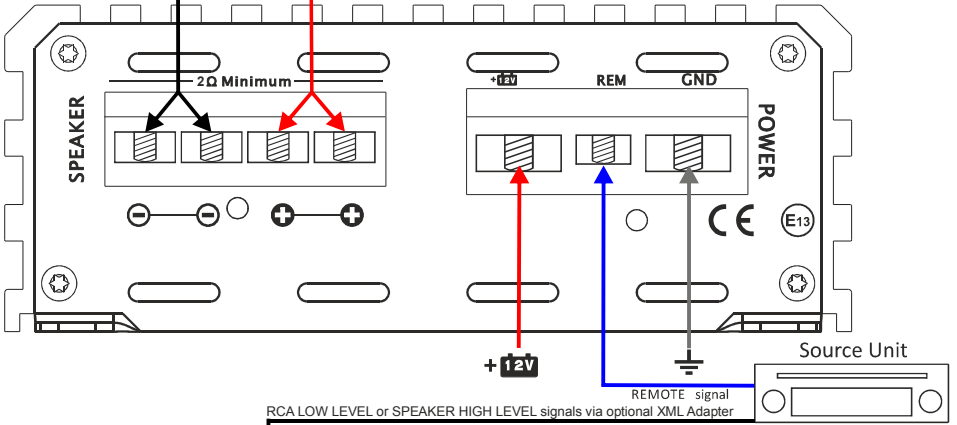

WIRING DIAGRAM

Fig 5. HXA 1K / HXA 2K / HXA 3K / HXA 4K / HXA 5K wiring
(2 Amplifier BRIDGE Mode - SIGNAL and SPEAKER)

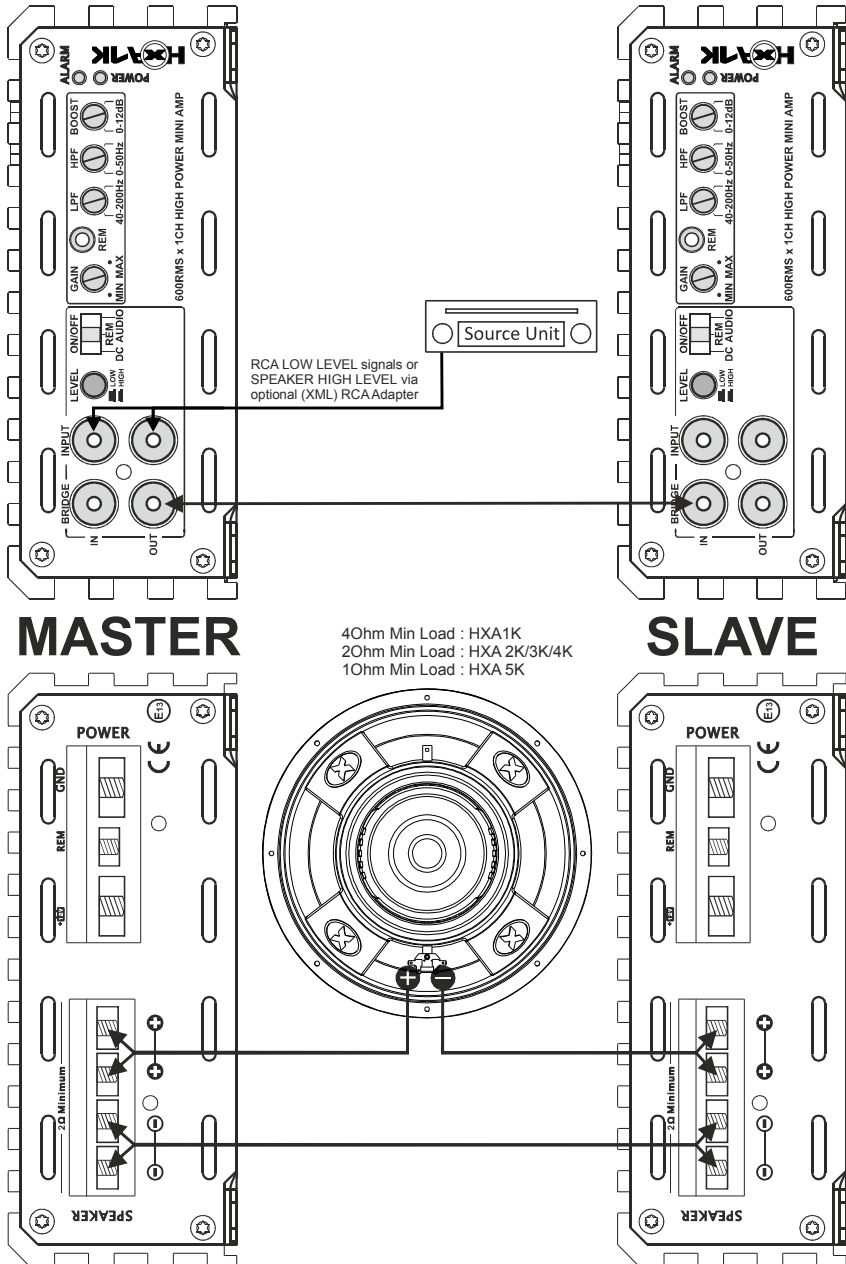

TROUBLE SHOOTING

Symptom	Possible Remedy
Amplifier will not power up	<p>Check to make sure you have a good ground connection.</p> <p>Check that there is battery power on the (+)terminal .</p> <p>Check all fuses, replace if necessary .</p> <p>Make sure that the Protection LED is not illuminated.</p>
Protection LED Comes on	<p>Check for short circuits on speaker leads.</p> <p>Check the speaker load not beyond the minimum load.</p> <p>Remove speaker lead, and reset the amplifier. If the protection LED still Comes on, then the amplifier is faulty and needs servicing .</p>
No output	<p>Check that the RCA audio cables are plugged into the proper inputs.</p> <p>Check all speakers wiring.</p> <p>Check the headunit output and the amplifier level setting.</p>
Low output	<p>Reset the level Control.</p> <p>Check the Crossover Control settings.</p>
High hiss in The speakers	<p>Check the RCA cable is not shorted to power ground at amplifier side.</p> <p>Check the amplifier grounding.</p>
Distorted sound	<p>Check that the Input level control is set to match the signal level of the head unit. Always try to set the Input level as low as possible.</p> <p>Check that all crossover frequencies are properly set.</p> <p>Check for short circuits on the speaker leads.</p>
Amplifier gets Very hot	<p>Check that the minimum load impedance for the amplifier model is correct.</p> <p>Check that there is good air circulation around the amplifier. In some applications, It may be necessary to add an external cooling fan .</p>

HXA Amplifier Feature

- COMPACT SIZE AND TINY FOOTPRINT.
- DOUBLE SIDE PCB AND SMD COMPONENTS.
- FULL MOSFET DESIGN.
- LPF, HPF AND BPF CROSSOVER.
- ADJUSTABLE BASSBOOST.
- 0.5 OHM LOAD STABLE FOR HXA5K
- NOISE FREE DESIGN.
- OVERLOAD, OVERHEAT, HIGH/LOW VOLTAGE PROTECTION.
- RoHS COMPLIANT.
- AUTO TURN ON/OFF via DC or AUDIO
- ALL MONO AMPLIFIER BRIDGEABLE
- OPTIONAL REMOTE CONTROLE



EXCURSION LIMITED WARRANTY POLICY

EXCURSION Intl. offers limited warranty on EXCURSION products under normal use on the following terms:

EXCURSION Amplifiers are to be free of defects in material and workmanship for a period of one year.

This warranty applies only to EXCURSION products sold to consumers by Authorized EXCURSION Dealers in Germany. Products purchased by consumers from an EXCURSION dealer in another country are covered only by that country's Distributor and not by EXCURSION Intl.

This warranty covers only the original purchaser of EXCURSION product. In order to receive service, the purchaser must provide EXCURSION with the receipt stating the consumer name, dealer, product and date of purchase.

Products found to be defective during the warranty period will be repaired or replaced (with a product deemed to be equivalent) at Excursion`s discretion and will not be liable for incidental or consequential damages. EXCURSION will not warranty this product under the following situations:

- * **Amplifiers received with apparent rust or corrosion**
- * **Any evidence of liquid damage or exposure to excessive heat**
- * **Attempted repairs or alterations of any nature**
- * **Product that has not been installed according to this owner manual**

Any implied warranties including warranties of fitness for use and merchantability are limited in duration to the period of the express warranty set forth above. No person is authorized to assume for EXCURSION any other liability in connection with the sale of this product.

Please call prior your authorized EXCURSION dealer the product got purchased. In case they are not accessible call 0961-416-0420 for EXCURSION Customer Service. You must obtain an RA# (Return Authorization Number) to return any product to EXCURSION Intl. The RA number must be prominently marked on the outside of the shipping carton or the delivery will be refused. Please pack your return carefully! We are not responsible for items damaged in shipping. Return the defective product along with a copy of the original dated retail sales receipt, plus 10,- EUR for handling and diagnostic evaluation to:

EXCURSION Intl. - A Division of CHPW
Attn: Returns (RA#)
Neustaedter Str. 20
D-92685 Floss / Germany



...is all you need

EXCURSION - A Division of CHPW

All Rights reserved - Intl. Trademark No: 010 640 597

Friedrich-Ebert-Str. 42 - D-92637 Weiden / Germany
Tel: (+49) 961-416 04 20 - Fax: (+49) 961-46 04 41

