

# What you need

Allen key    screwdriver

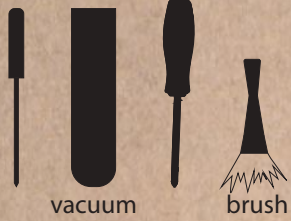

# HOW TO CLEAN & CHANGE BURR OF YOUR ATOM SPECIALTY



YOUR COFFEE EXPERIENCE

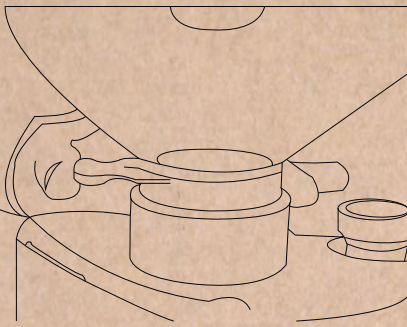

① Close the hopper tab and grind the residual coffee beans

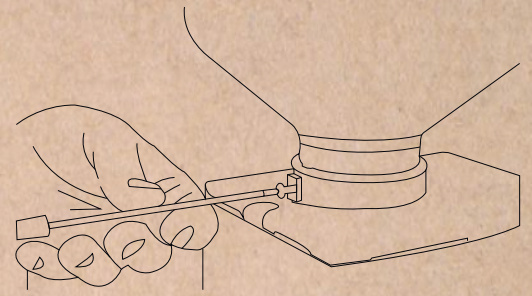

②

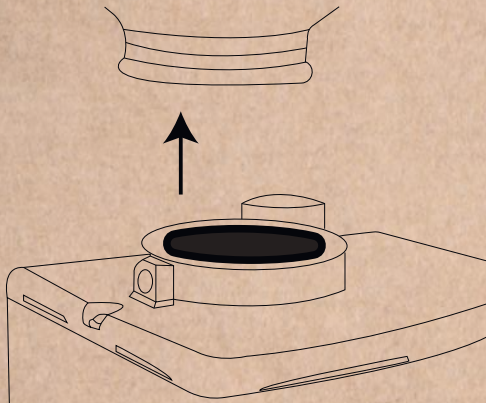

③

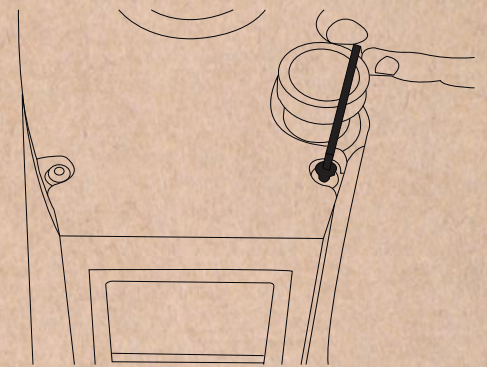

④ Unscrew the cover

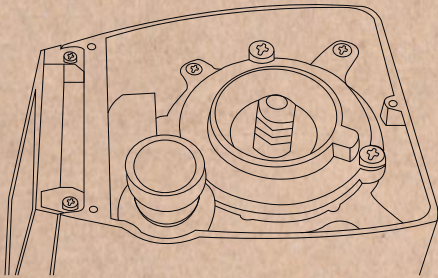

⑤

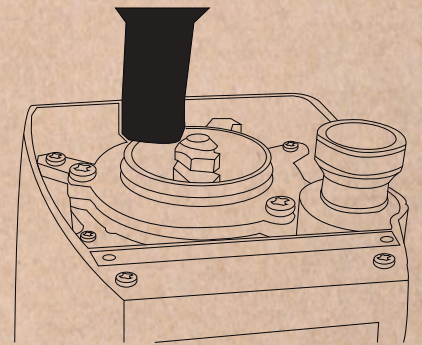

⑥ First cleaning of the grinding chamber

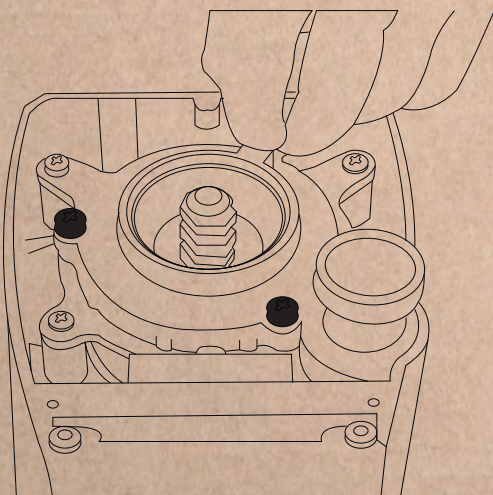

⑦ Unscrew the upper burr holder

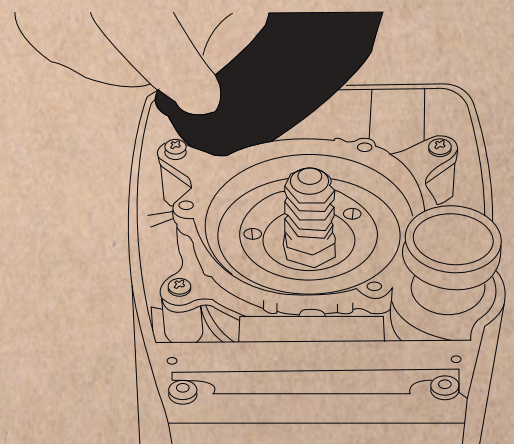

⑧

# HOW TO CLEAN & CHANGE BURR OF YOUR ATOM SPECIALTY



YOUR  
COFFEE  
EXPERIENCE

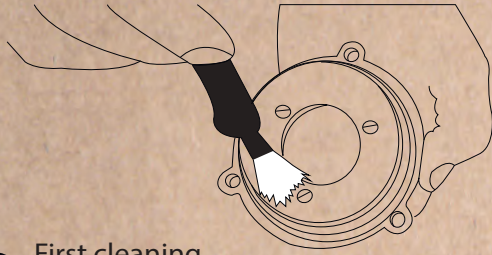

9 First cleaning of the upper burr

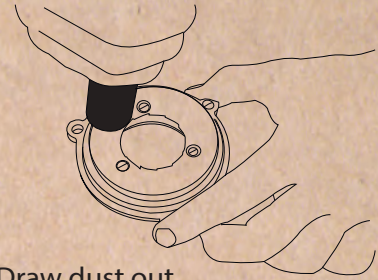

10 Draw dust out from the upper burr

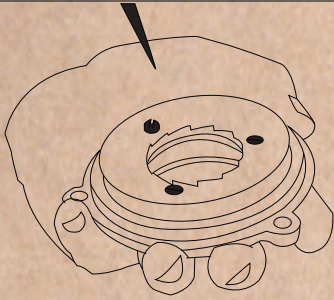

11 Take the upper burr out from the upper burr holder

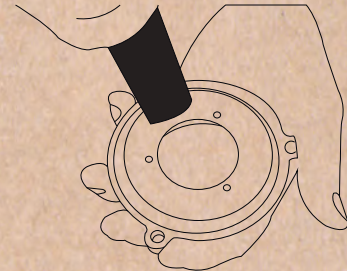

12 Draw dust out from the upper burr holder

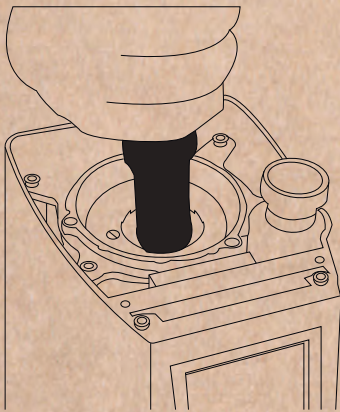

13 Draw dust out from the lower burr

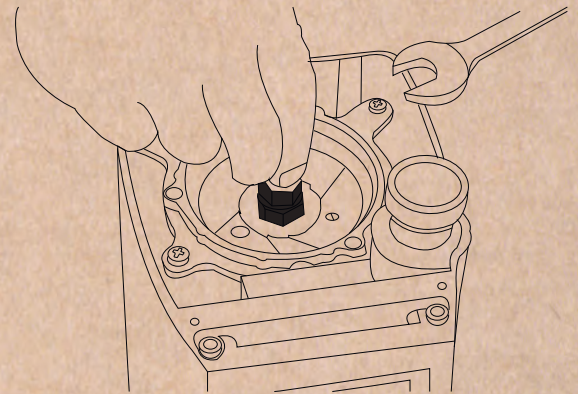

14 Unscrew and take out the lower burr

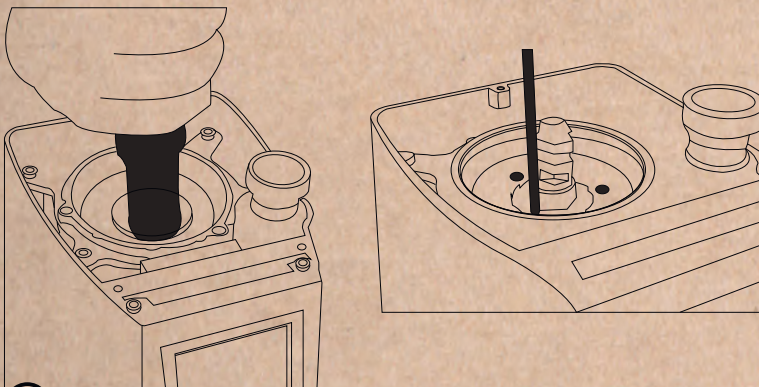

15 Remove the coffee residue from the grinding chamber  
Put the lower burr back

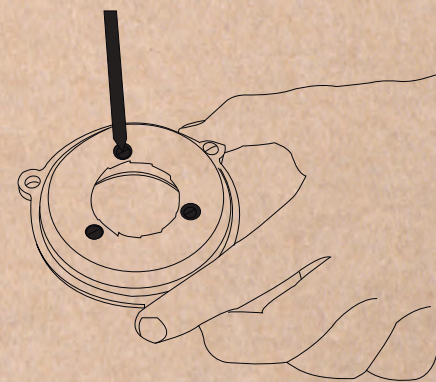

16 Replace the upper burr on the upper burr holder

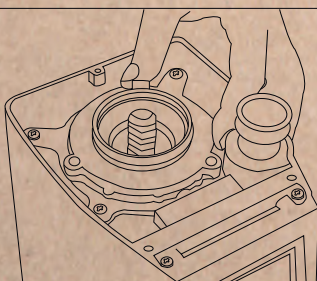

17 Put the upper burr holder back

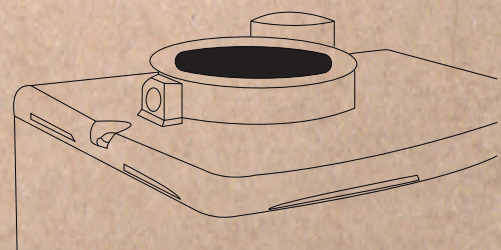

18 Replace the cover