









Instruktion för LED Grow Light Garden Kit - 01

Specifikation över delar:

<p>A</p>  <p>Sida (X1)</p>	<p>B</p>  <p>Sida (X1)</p>	<p>C</p>  <p>Tvärstång (X5)</p>	<p>D</p>  <p>HEX-skruv (X10)</p>	<p>E</p>  <p>Justerbar fot (X4)</p>
<p>F</p>  <p>HEX-nyckel (X1)</p>	<p>G</p>  <p>LED-enhet (X1)</p>	<p>H</p>  <p>Strömsladd (X1)</p>	<p>I</p>  <p>Buntband (X2)</p>	

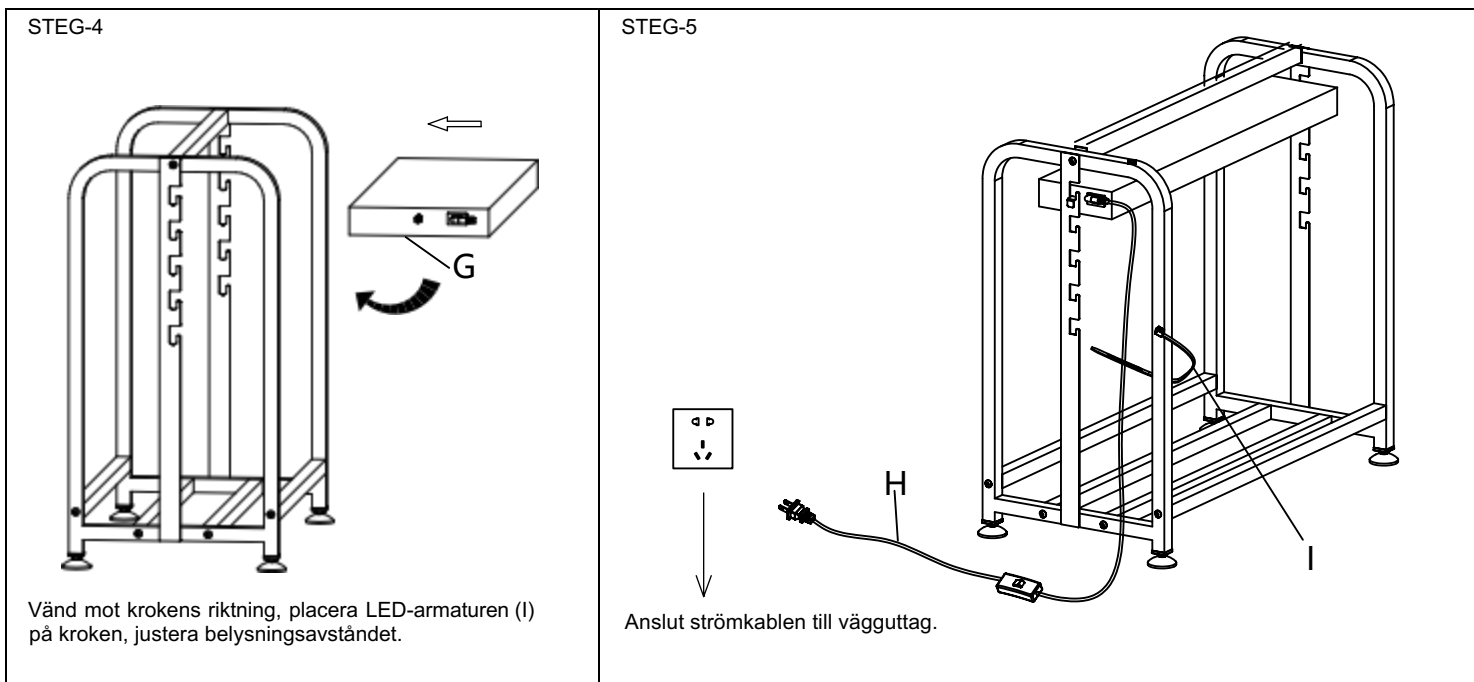
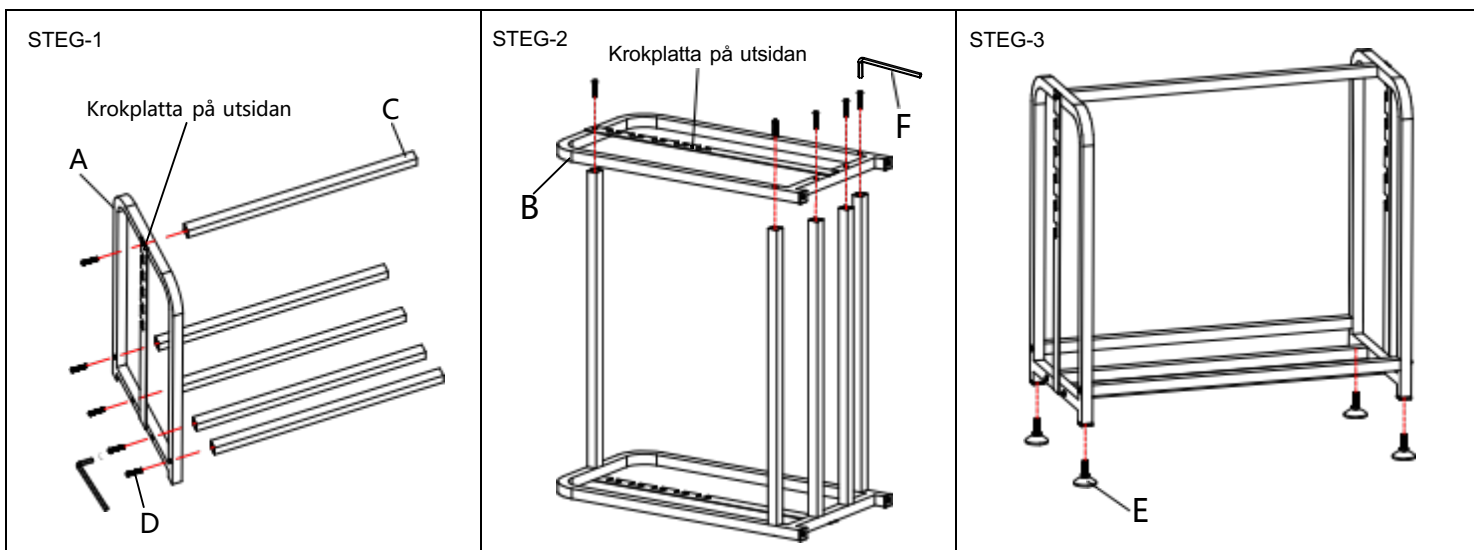

Varning

- Vattna försiktigt så att LED-enheten inte blir blöt.
- Stäng av strömmen och dra ut strömkabeln ur vägguttaget innan du utför underhåll eller rengöring.
- Undvik att titta rakt in i den tända belysningen.