



Q-LIGHT Nissan Interstar 24-

Art nr: Q900507
Monteringsatts: 93681



Installation

Produkten monteras i krockbalken



QPAX AB® Pellvägen 4, S-827 63 Färila
Telefon: +46(0)651-760 460 | E-post: info@qpax.se | qpax.se

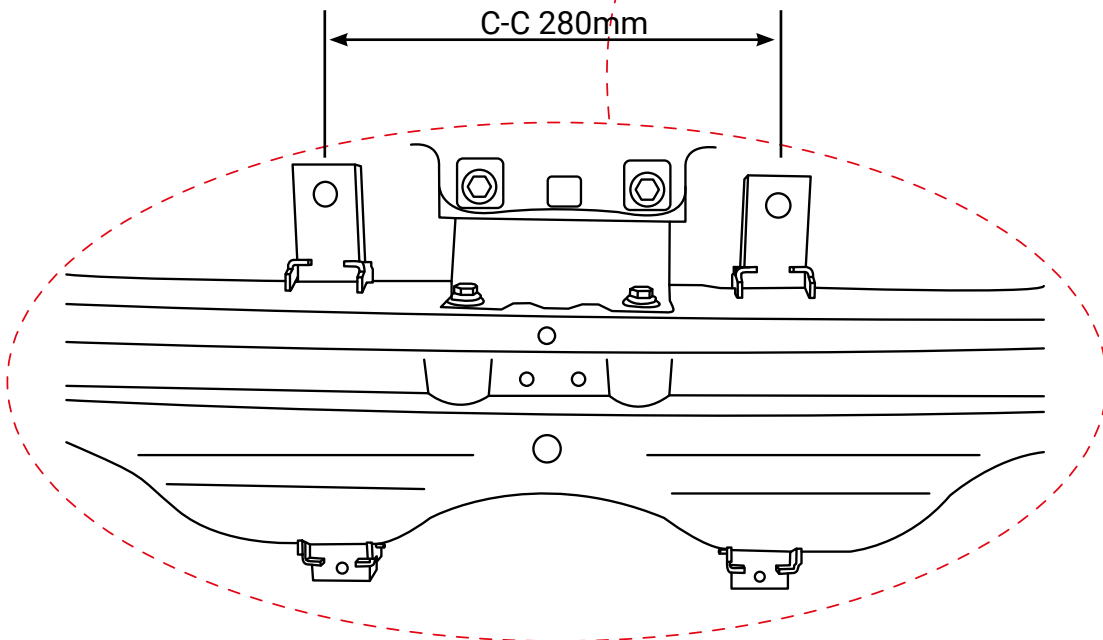
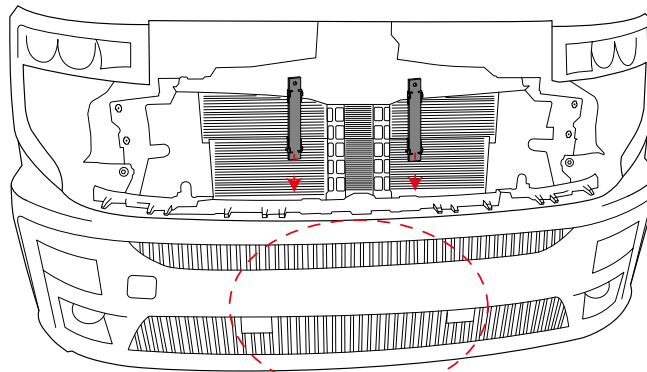
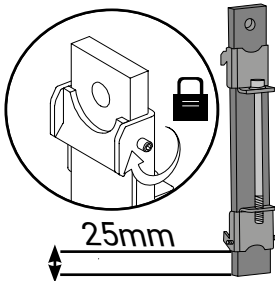
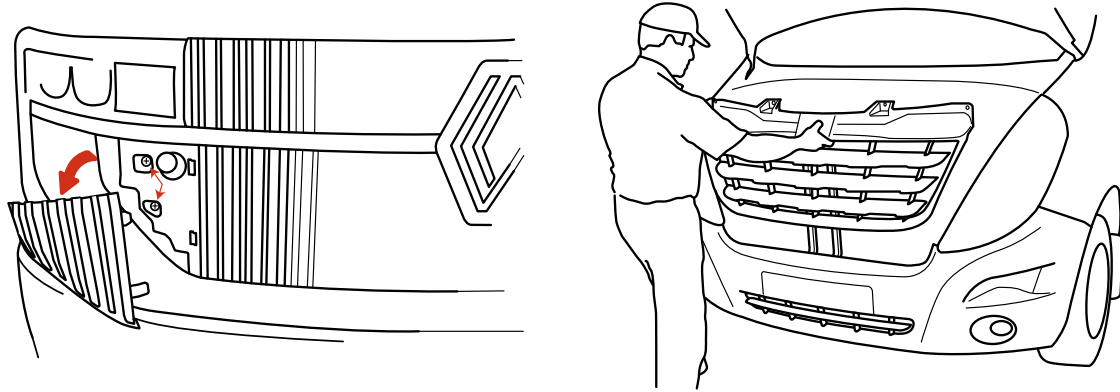

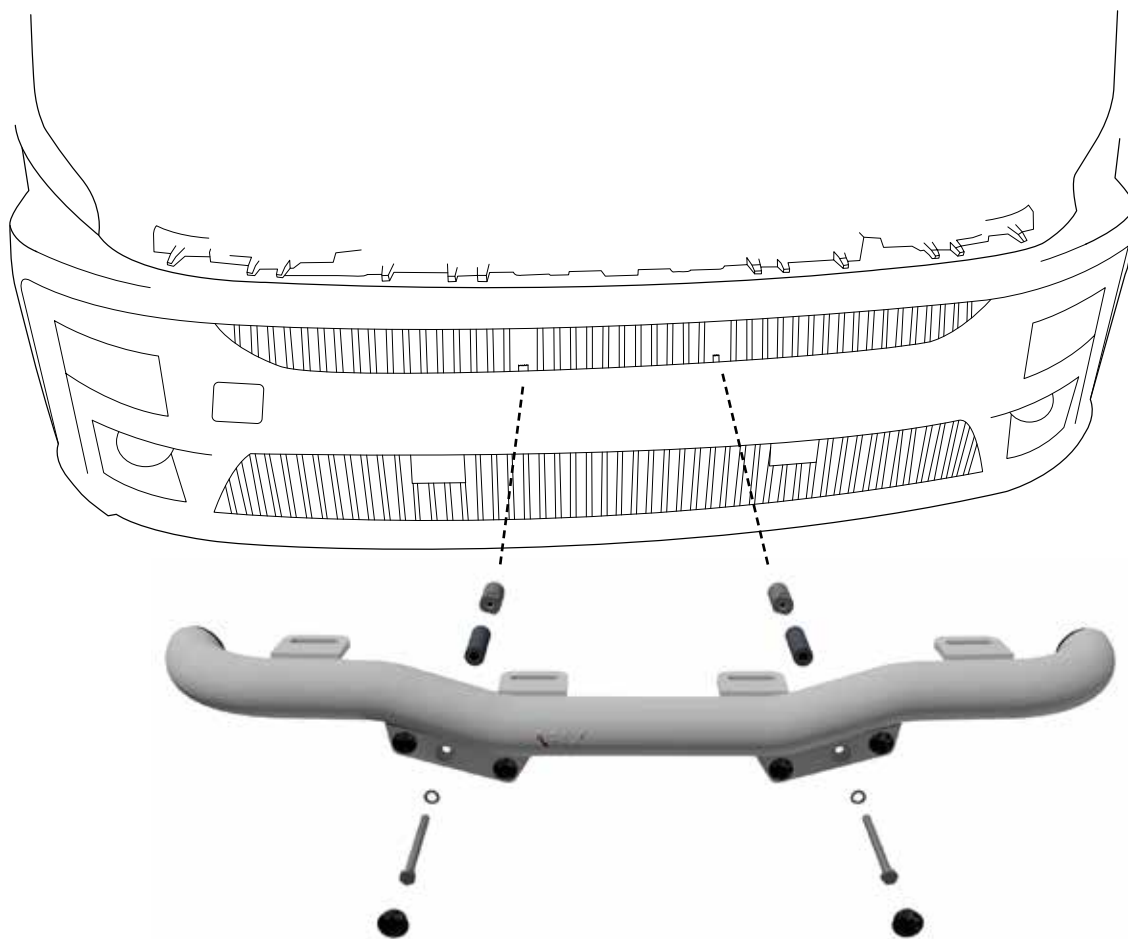
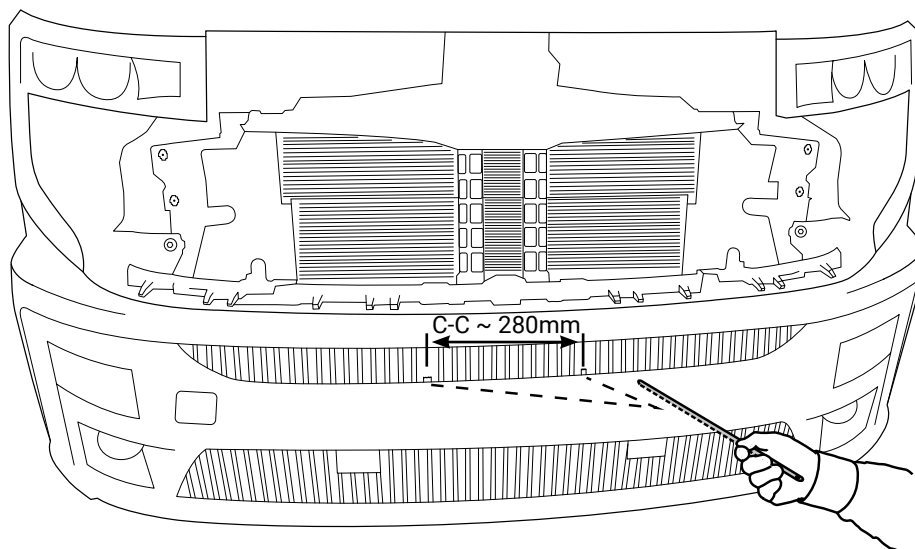

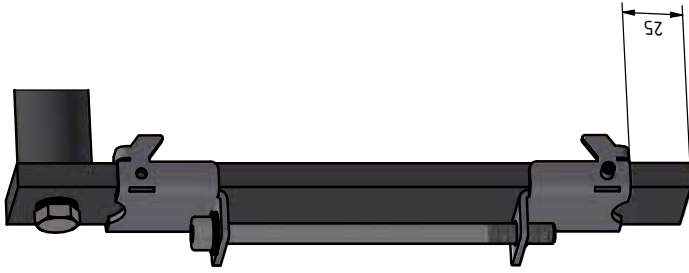

Pos	Ant	SMST Titel	Dimension	Artikel nr/Referens
17	1	Reklamlist Opax		98021
16	4	Stoppskruv	M5x8	34.114
15	2	Q-GRIP Klo 0-8 gänga	T=3	100.155
14	2	Q-GRIP Glidstång 275mm	40x10x275	100.157
13	2	Bricka Nordlock M10	M10	34.327
12	2	Skruv M6S	M10x30	34.106
11	2	Q-GRIP Klo 0-8	T=3	100.156
10	2	Bricka Nordlock M8 Bred	M8	34.328
9	2	Skruv MC6S	M8x140	34.174
8	2	Q-GRIP Ståldistans Ø30x60	Ø30x60	100.162
7	2	Aludistans 100	Ø25x100	108.99
6	2	Bricka fjäder M8 rostfri	15x8,6x0,8	34.329
5	2	Skruv M6SH	M8x120	34.151
4	6	Täcklock Ø20mm håll	Ø25(20)x10	50.937
3	1	Dekal QPAX	54x17	60.325
2	2	Täcklock	T=5	101.140
1	1	Q-LIGHT extraljusfäste	E63-152	

Denna handling får inte kopieras utan vårt skriftliga medgivande och dess innehåll får inte yppas för tredje man och inte heller användas för något obehörigt ändamål.

Konstr	Ritad	Kop.	Kontr.	Stand.	Godk.	Skala	Ersätter	Ersatt av
JNO	JNO					1 : 4		
Q-LIGHT 4 Design Nissan Interstar 24-								
							Datum 2025-11-20	
Tel: +46 (0)61 566 460 Mail: info@opax.se							Art. nr 93681	
Dnr ej annat anges, gäller SS-ISO 2768 - C och SMS 723 - B. Sverkevärd för sveitar enligt SS - ISO 9817 nivå C.							Rev A	