

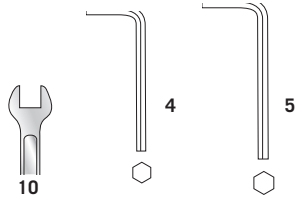

Detta behöver du:  
You will need this:

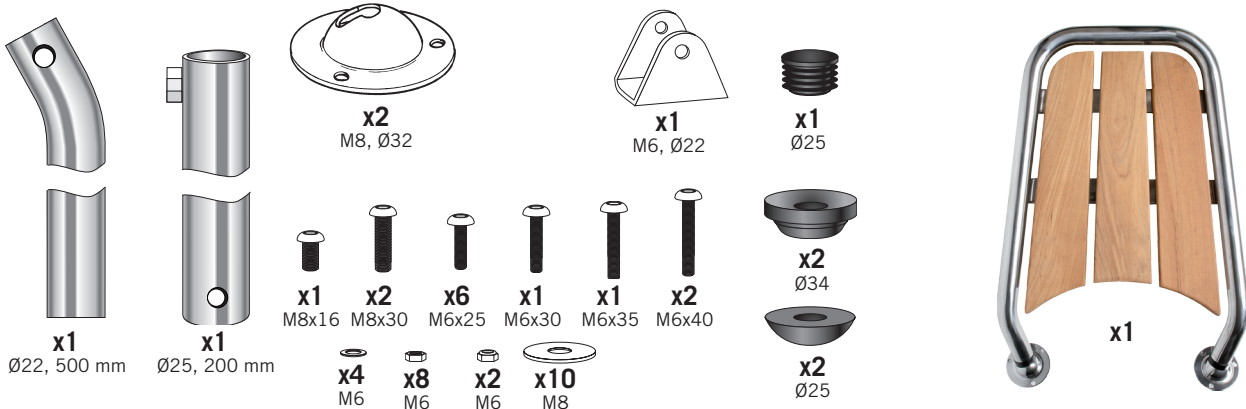

1



2

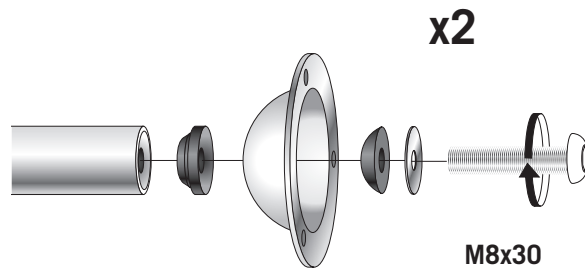
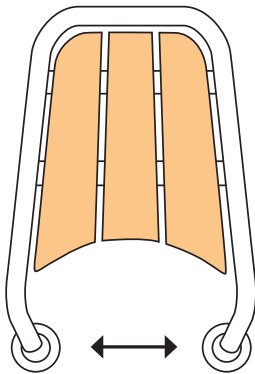

3

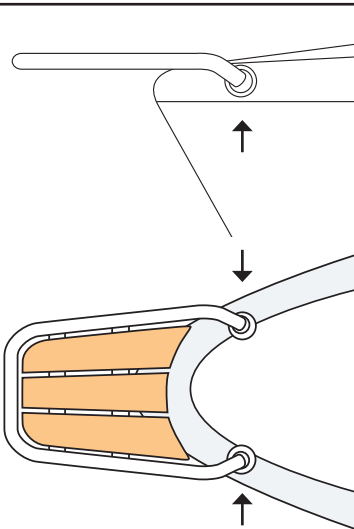

4 a-d

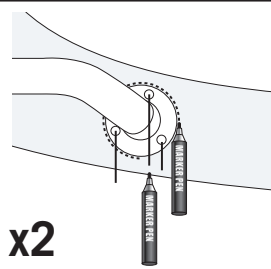

4a

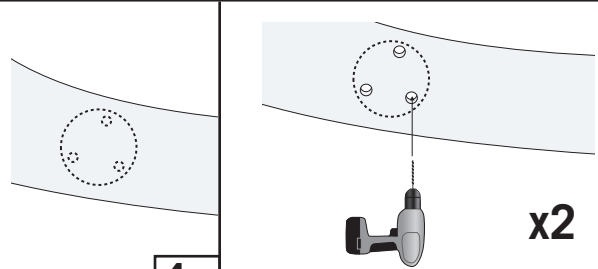

4b

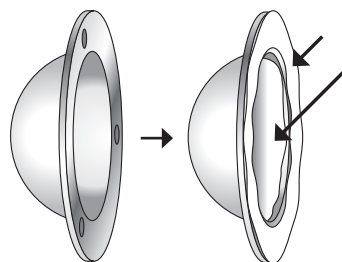

4c

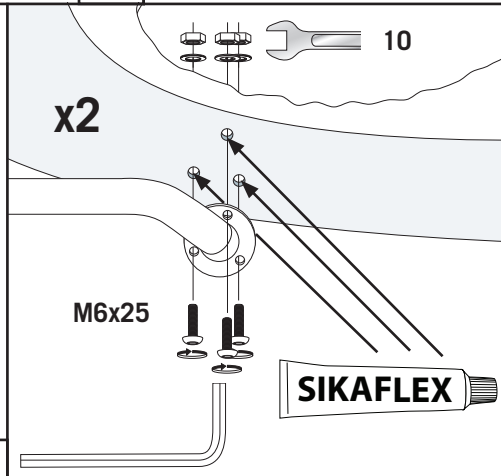

4d

