

# Three-piece Post

Tredelad stolpe • Dreiteiliger Pfosten •  
Poteau en trois parties

WG908

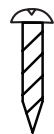
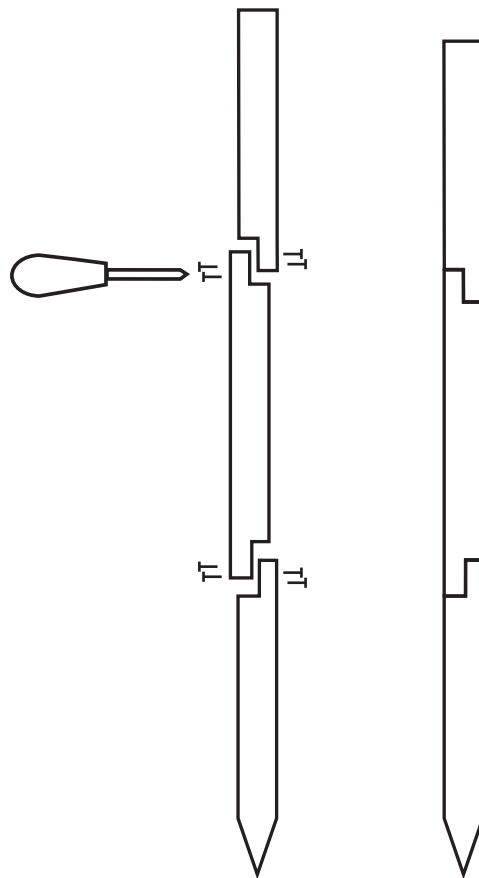

8 X

 WILDLIFE  
GARDEN

[www.wildlifegarden.com](http://www.wildlifegarden.com)

# Contents

Innehåll • Inhalt • Contenu

## **Multiholk**

Multiholk • Multiholk • Multiholk.....3

## **Bird Feeder with Bath**

Fågelmatare med bad • Vogelfutterspender mit Bad • Mangeoire avec Bain.....4

## **Butterfly Hibernation Box**

Fjärilsholk • Schmetterlingskasten • Maison à papillons.....5

## **Squirrel Feeder**

Ekormatare • Eichhörnchen Futterbox • Mangeoire pour écureuils.....6

## **Balcony Nesting Box**

Balkongholk • Balkonnistkasten • Nichoir à balcon.....7

## **Bee Nest**

Biholk • Bienen-Hotel • Abri pour Abeilles.....8

# Multiholk

Multiholk • Multiholk • Multiholk

WG101 - WG119, WG215, WG1122 - WG1124

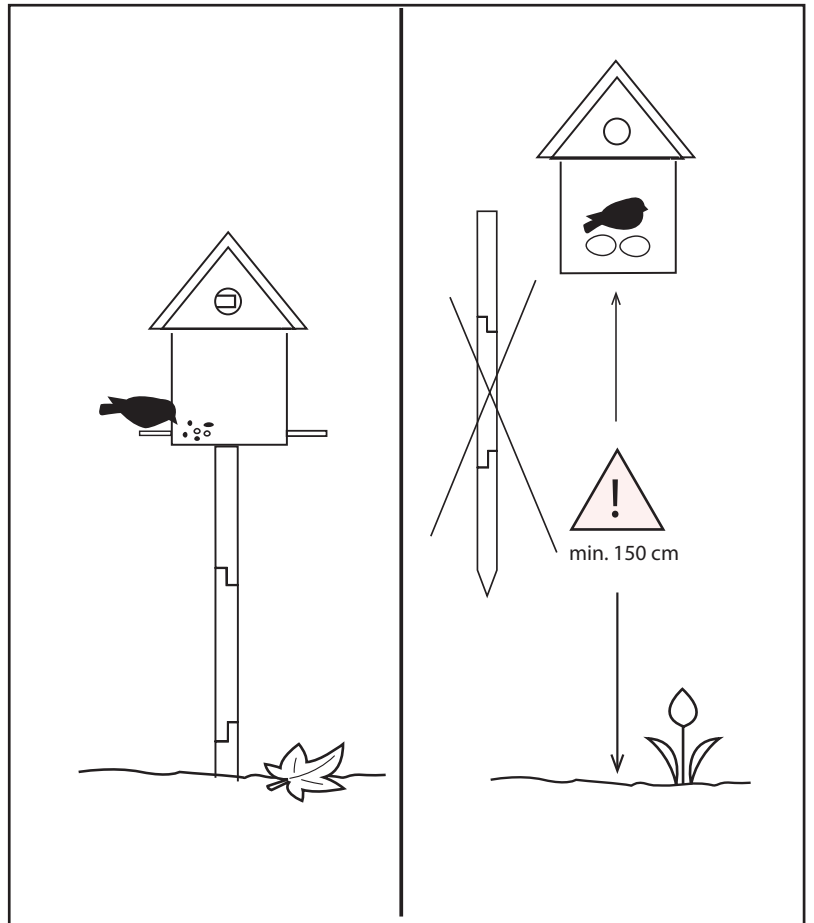
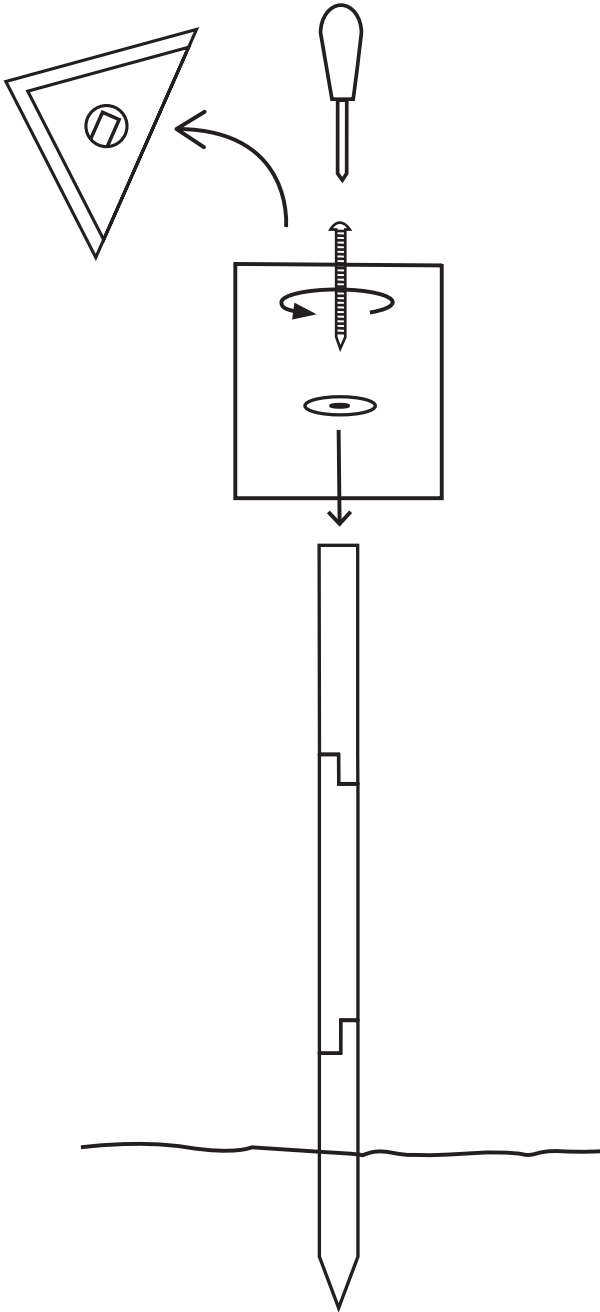

W101-WG119, WG215, WG1122-WG1124

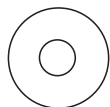
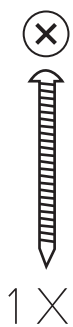

3



# Bird Feeder with Bath

Fågelmatare med bad • Vogelfutterspender mit Bad •

Mangeoire avec Bain

WG352, WG355 - WG356

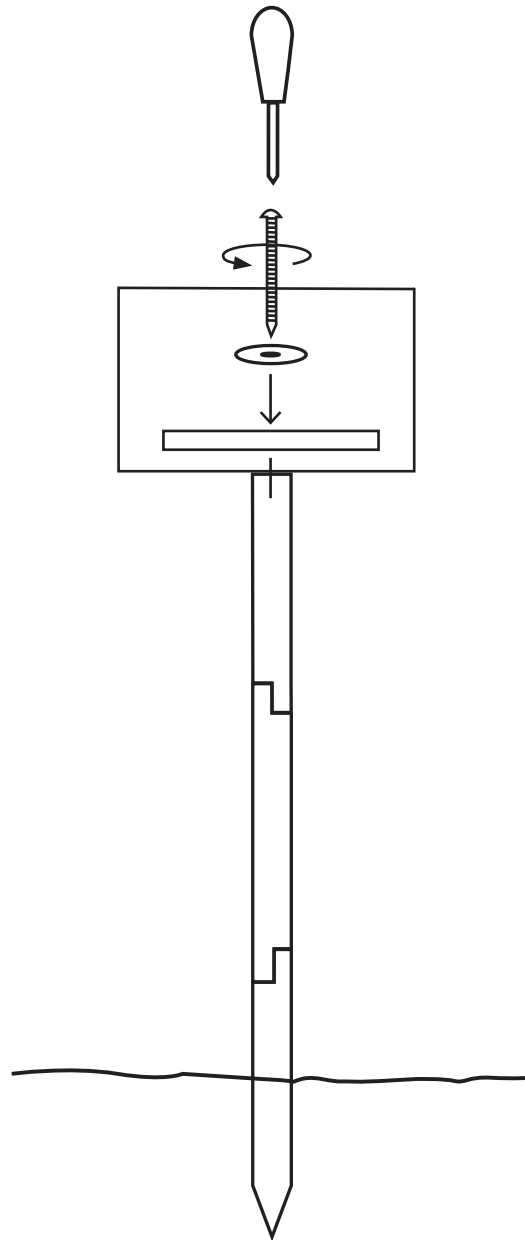

WG352, WG355, WG356

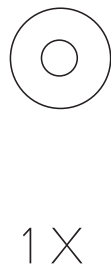
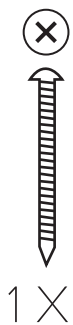

# Butterfly Hibernation Box

Fjärilsholk • Schmetterlingskasten • Maison à papillons

WG300, WG303

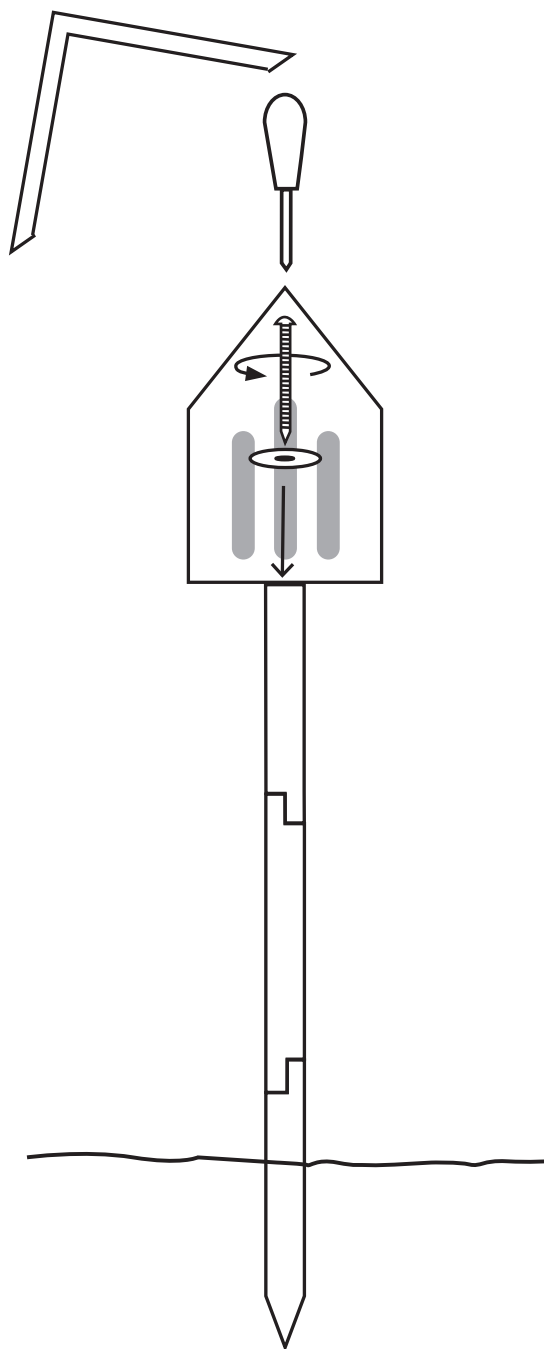

WG300, WG303

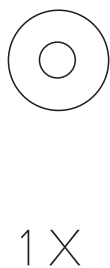
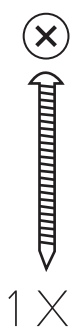

5



# Squirrel Feeder

Ekormatare • Eichhörnchen Futterbox •

Mangeoire pour écureuils

WG313 - WG314

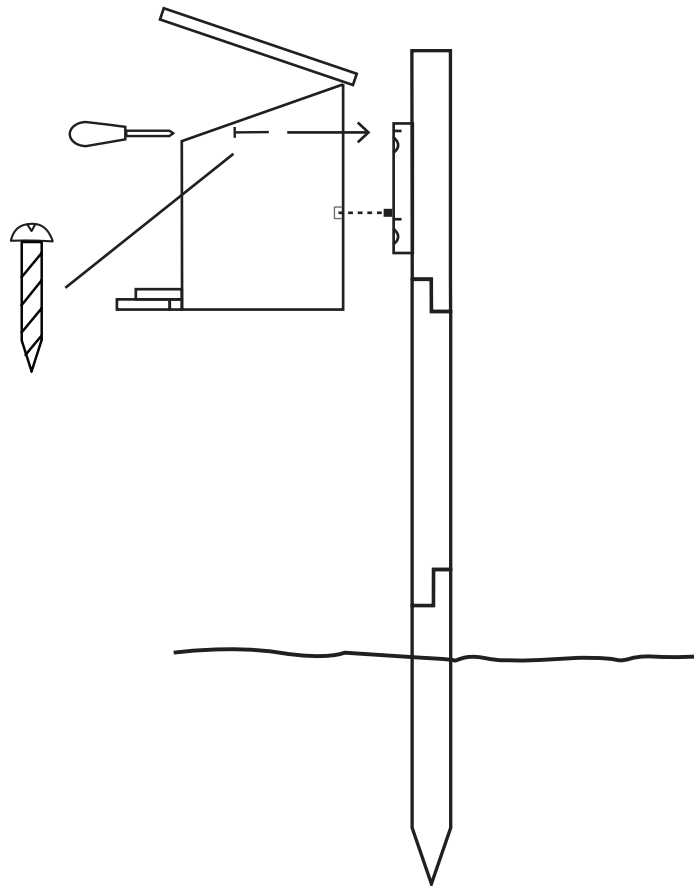
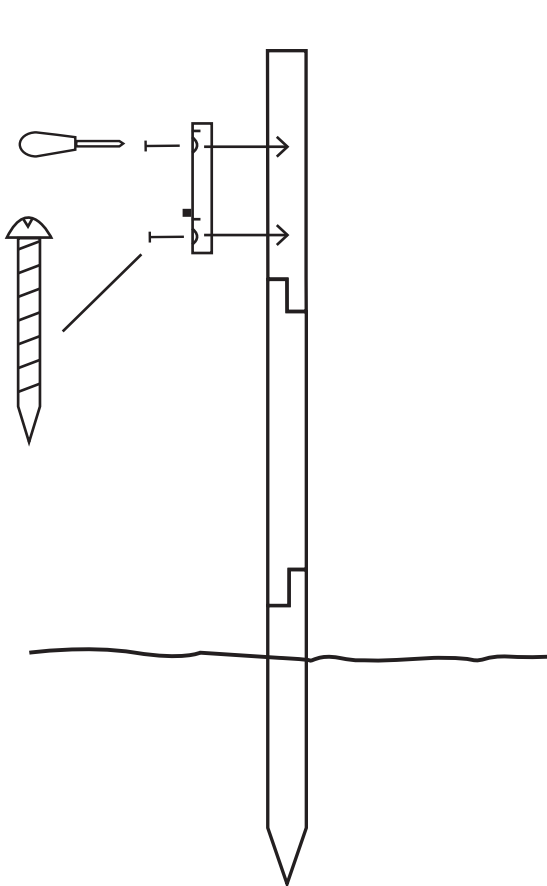
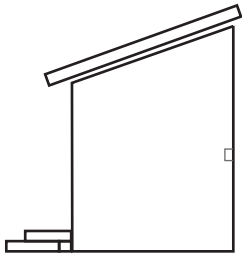

WG313 - WG314



2 X

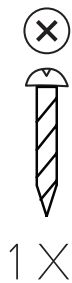

1 X

6



# Balcony Nesting Box

Balkongholk • Balkonnistkasten •

Nichoir à balcon

WG251 - WG253

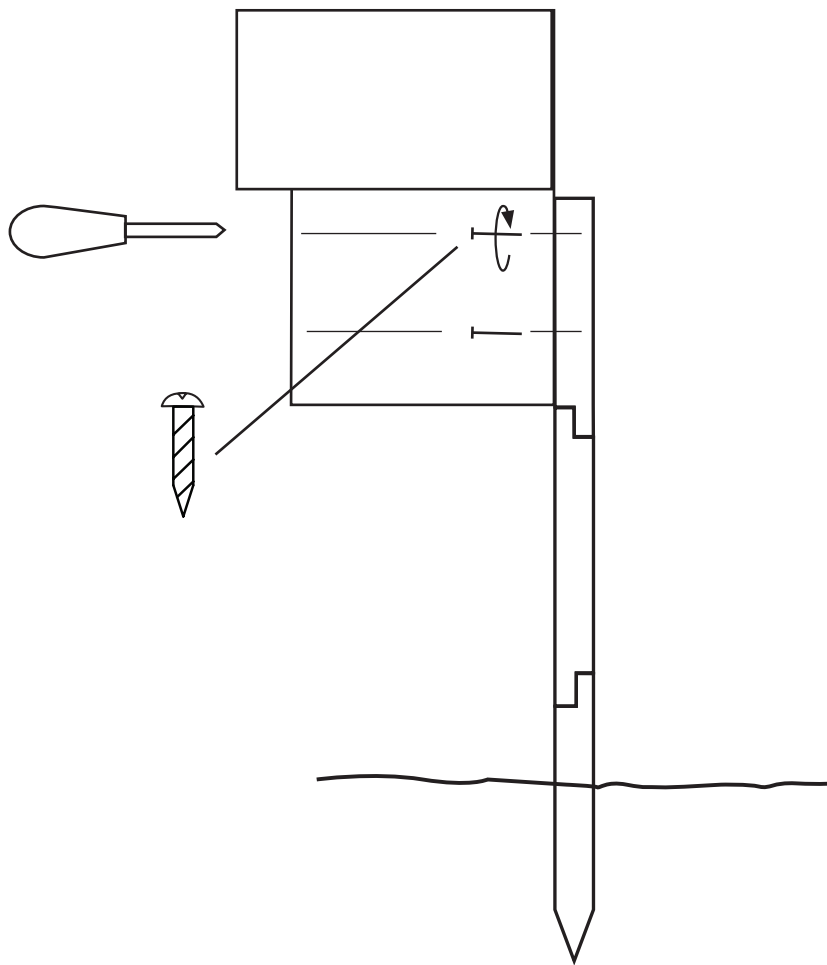

WG251 - WG253

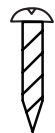

2 X

7



# Bee Nest

Biholk • Bienen-Hotel • Abri pour Abeilles

WG311 - WG312

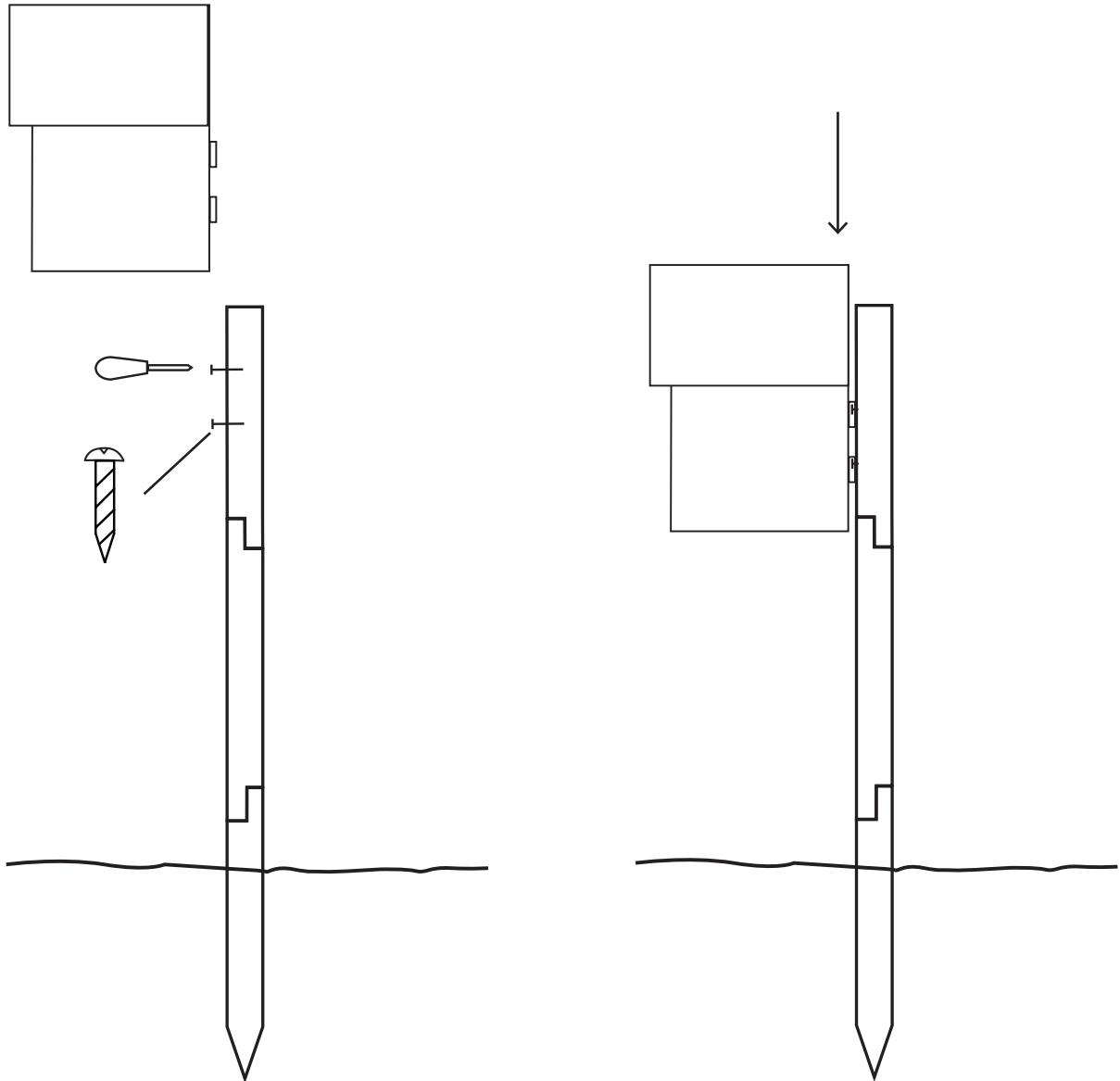

WG311 - WG312

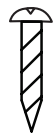

2 X

8

