

# RF Wireless LED Dimmer

Model:SR-2801F with SR-2501N series



## Feature

- Reliable stable switch and dimming control function, control range  $\geq 20M$ .
- Battery in the remote is with long life span. It normally can use for 2 years.
- Switch on/off of lightings slowly, without any flash, meet the comfort of human eyes.
- Dimming range 0.1-100%.
- Use with power repeater to expand the output power unlimitedly.
- Enable to control four zones separately, And dim or ON/OFF four zones at same time ,each zone can be set endless receivers, each receiver maximally be controlled by 8 different remotes.
- Enable be dimmed and ON/OFF by push button after connecting receivers.
- Receivers can work with RF-WIFI converter after installing software on IOS and Android system.
- Push dim function

## Parameter

### Remote

Part No.	Operation Voltage	Operation Frequency	DIMENSIONS $\phi/h$ (mm)	REMARKS
SR-2801F	3VDC	434MHz/868MHz	39x136.5x10.7	RF Wireless

### Receiver

Part No.	Input Voltage	Current	Output	Remarks
SR-2501N	12-36VDC	4x5A	4x(60-180)W	Constant voltage
SR-2501NEA	12-36VDC	4x8A	4x(96-288)W	Constant voltage
SR-2502N	12-36VDC	4x350mA	4x(4.2-12.6)W	Constant current
SR-2503N	12-36VDC	4x700mA	4x(8.4-25.2)W	Constant current

## Product Size

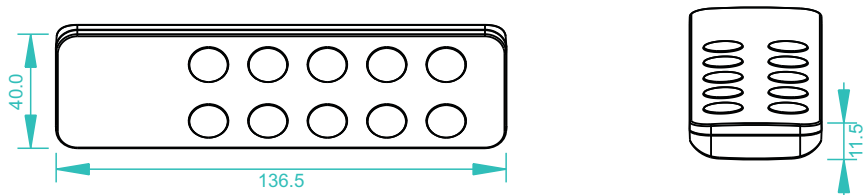

## Wiring diagram

### 1)Receiver Connection Diagram for Single Unit

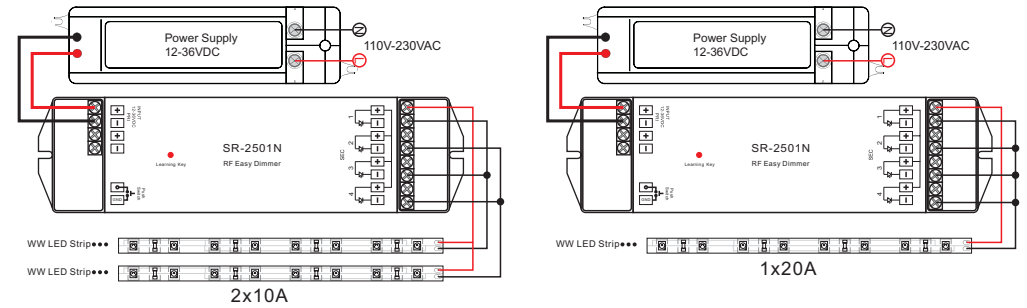
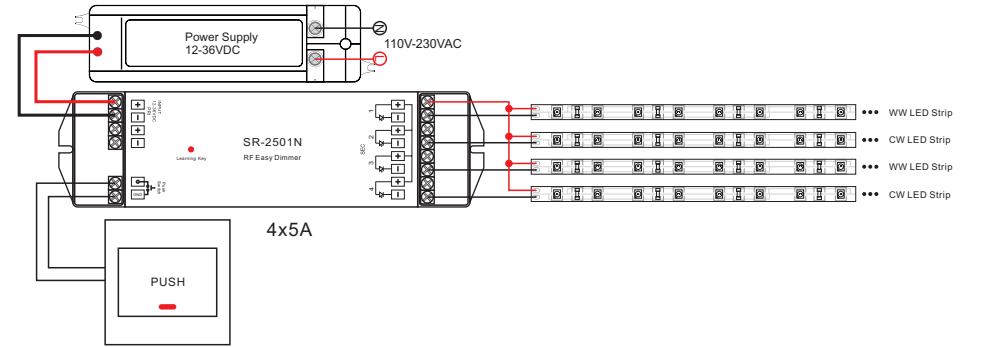



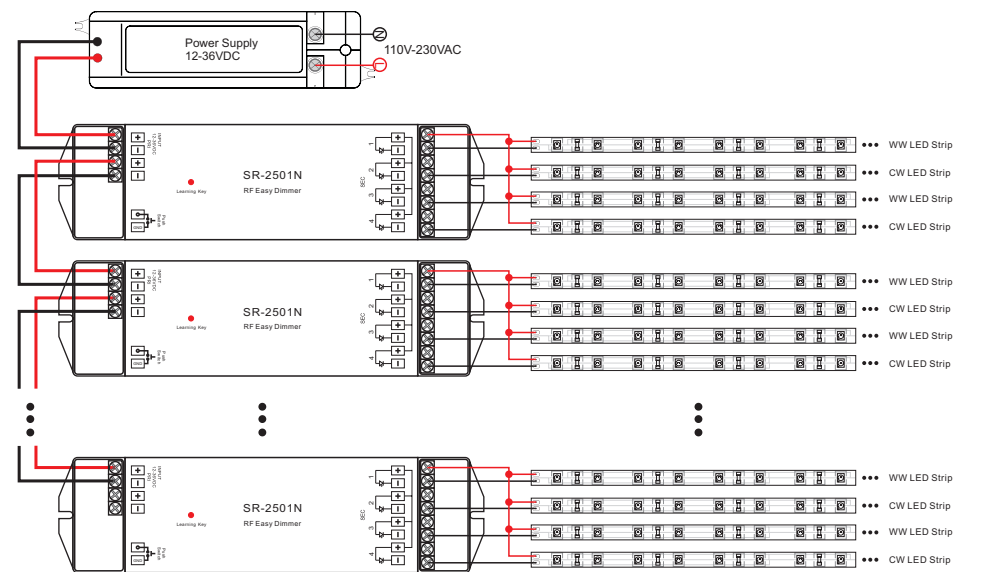





### 2)Receiver Connection Diagram for Multiple Units



## Operation

After you have wired all the receivers according to Figure illustration you need to do the following:

1. Pull off the plastic film cover of the battery at the back of remote.
2. Pair remote and receiver: short press the Learning Key on the receiver, then immediately short press the  or . Once you do that, the LED lights will blink once. Now your remote and receiver are paired! Do the same for the other receivers if you use them, you can add as many optional receivers as you wish.
3. Press  and  can dim 4 zones brightness independently.  
Long press : dim brightness from 0.1%-100%.  
long press : dim brightness from 100%-0.1%.  
 and  switch on/off 4 zones together.

### Memory Reset:

In case you want to reset the memory of the receiver, press the learning function button for 10 seconds while the unit is being powered. The unit will then reset to factory defaults.

4 zones remote

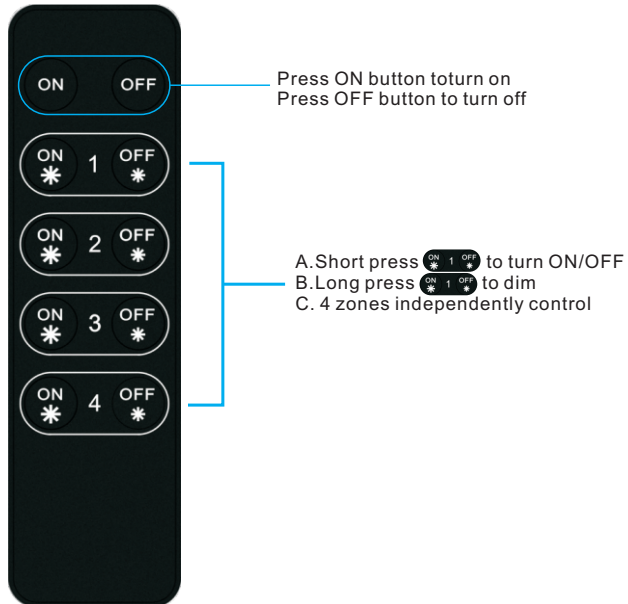

## Safety & Warnings

- 1) The product shall be installed and serviced by a qualified person.
- 2) IP20. Please avoid the sun and rain. When installed outdoors, please ensure it is mounted in a water proof enclosure.
- 3) Always be sure to mount this unit in an area with proper ventilation to avoid overheating.
- 4) Please check if the output voltage of any LED power supplies used comply with the working voltage of the product.
- 5) Never connect any cables while power is on and always assure correct connections to avoid short circuits before switching on.
- 6) Please ensure that the cable is secured tightly in the connector
- 7) For update information please consult your supplier.

## Warranty Agreement

- 1) We provide lifelong technical assistance with this product:
  - 3-year warranty. We print date on every products, for example :1125 means year 2011, week 25. The warranty is for free repair or replacement and covers manufacturing faults only.
  - For faults beyond the 3-year warranty we reserve the right to charge for time and parts.
- 2) Limited Warranty
  - Any defects caused by wrong operation.
  - Any damages caused by unauthorized removal, maintenance, modifying, incorrect connection and replacement of chips.
  - Any damages due to transportation, vibration etc. after purchase.
  - Any damages caused by earthquake, fire, lightning, pollution and abnormal voltage.
  - Any damages caused by negligence, inappropriate storing at high temperatures and humidity or near harmful chemicals.
  - Product has been updated
- 3) Repair or replacement as provided under this warranty is the exclusive remedy to the customer.